An Introduction to Architectural Design: *Theaters & Concert Halls, Part 1*

Course No: A05-001

Credit: 5 PDH

J. Paul Guyer, P.E., R.A., Fellow ASCE, Fellow AEI



Continuing Education and Development, Inc.
9 Greyridge Farm Court
Stony Point, NY 10980

P: (877) 322-5800

F: (877) 322-4774

info@cedengineering.com

An Introduction to Architectural Design: Theaters and Concert Halls, Volume 1



J. Paul Guyer, P.E., R.A.

Paul Guyer is a registered civil engineer, mechanical engineer, fire protection engineer and architect with 35 years of experience designing buildings and related infrastructure. For an additional 9 years he was a principal staff advisor to the California Legislature on capital outlay and infrastructure issues. He is a graduate of Stanford University and has held numerous national, state and local offices with the American Society of Civil Engineers, Architectural Engineering Institute and National Society of Professional Engineers.

CONTENTS

1. INTRODUCTION
2. ROOM CHARACTERISTICS
3. DRAMA ROOM QUALITIES
4. MUSIC ROOM QUALITIES
5. THE HOUSE
6. THE STAGE
7. PRIMARY AND SECONDARY USES

(This publication is adapted from the Unified Facilities Criteria of the United States government which are in the public domain, have been authorized for unlimited distribution, and are not copyrighted.)

(This is the first in a series of volumes under editorial development dealing with planning and design of theaters and concert halls.)

1. INTRODUCTION. Theater and concert hall design is both artistically and functionally complex. As in all architectural design, the making of qualitatively effective and technically functional space at an economical cost is paramount, but compared to other architectural building types, performance facilities are set apart by sophisticated electro-mechanical devices and technology needed to support performance. The ultimate fine-tuning of this balance of diverse, interdependent factors is the architectural engineer's particular responsibility. However, during the process of designing a music and drama center (MDC), many decisions must be made by the MDC staff and facilities engineers before the design professional is hired. The MDC planners must be familiar with information in this publication in order to complete the documentation required for project initiation and ensure that a project is in compliance with the Owner's standards for good design. It is also strongly recommended that technical consultants be brought into the design process as early as possible, preferably in the planning stage of design. In terms of project documentation this publication provides basic information for the development of the design criteria requirement. It should be utilized by using service staff, facilities engineers and technical consultants in program development, in formulating the functional requirements. This guide deals with the basic configurations and principles at work in performance facilities. It presents both general and specific guidance which affects the design for an MDC. It is organized in three divisions corresponding to the three primary spatial divisions: the facilities which bring performers and audience together in one or more controlled relationships; the facilities which support performers and production; and the facilities which support the audience and audience involvement. Each division begins with the largest, most inclusive definitions; disassembles them into manageable parts; points out how they are similar or dissimilar; and how they interlock. General standards for comparison and measurement will be developed along with the means for applying them to assist design guide users in finding relevant information within the logical context of their application.

2. ROOM CHARACTERISTICS

2.1 EXTERNAL RELATIONSHIPS. The heart of any performance facility is the Room, the place of performance. The Room includes seating and stage. The definition of all other activities and spaces within the facility relates to the activity of performance and the Room, either directly or indirectly. Audience facilities are directly related in terms of capacity and access, and indirectly by the desired ambience and image to be created. Backstage facilities are directly related in terms of scene handling, stage form and stage access requirements, and indirectly by the use of the Room for rehearsals and set assembly.

2.2 INTERNAL RELATIONSHIPS. The three primary variables affecting physical characteristics of the Room are size, shape and arrangement of participants. These interact in the following ways: Size is implied by seating capacity and by anticipated use of the stage. These factors vary with the formal relationship of the seating to the stage. Size is also linked to acoustic properties and perception of intimacy. Shape is implied by criteria for vision and hearing, and so interacts with size (volume and distance), but is most strongly defined by arrangement of people in the Room. Hence, the audience/performer relationship (arrangement) is physically and conceptually the first choice to be made. There are other variables: secondary considerations of accessory equipment, access to seating and stage, and appropriate environmental conditions also influence the physical character of the Room. Finally, questions of flexibility and adaptability stemming from the using service's program emphasis are very real factors of choice. These secondary and tertiary concepts will be introduced and developed as discussion goes on.

2.3 BASIC CHOICES. Major differences between music and drama first appear in Room design. However, there are a few important choices related to both uses; roughly corresponding to the three primary variables above. The choices are:

- Use of the Room for music, drama or both (shape).
- Relationship of audience and performers in Frontal, Thrust or Surround form.

- Estimated seating capacity (size).

In the context of performing arts program goals and constraints, the force of logic favors answers that amount to “most likely” choices, although it should not preclude variation.

2.3.1 USES. Will the Room be used for both music and drama, and if so, to what degree is each to be stressed? This question has many implications which will be discussed in conjunction with Room criteria for each use. This guide assumes that in all cases one use will dominate according to program emphasis.

2.3.2 ARRANGEMENT OF PARTICIPANTS. What will be the spatial and operational relationship of audience to performers? The most common forms this relationship takes, all recognize the separateness of stage and audience. These forms are called Frontal (proscenium), Thrust (projected), and Surround (arena). In many performing arts activities the Frontal form offers substantial advantages.

- The bulk of repertory and music literature assumes Frontal.
- A proscenium is a ready-made frame of reference for actors, directors, and technical designers.
- Performers and audience have established expectations based on experience with the most common (proscenium) theater form.
- A proscenium generally results in maximum impact of scenic effect.
- Scenery creates opportunity for backstage involvement of non-acting participants.
- Pre-designed stage equipment relationships are most likely to provide consistent built-in production quality, with a ‘memory’ for improvements.
- Incoming touring shows are typically designed for the most common theater form.
- Dance presentation will work if the stage is large enough.
- Variety revues find Frontal most adaptable to different acts.
- Public addresses, ceremonies and lecture demonstrations favor uniform viewing relationships.

- A range of music group sizes fit the stage, and established methods for adjusting acoustics are well developed.

2.3.3 AUDIENCE CAPACITY. How large should the House be? How many seats? In terms of audience size, basic design criteria such as viewing distance and acoustical characteristics determine capacity according to performance type, Room volume, and Room configuration. However, in order to begin planning a new facility one must have some general idea of potential audience size.

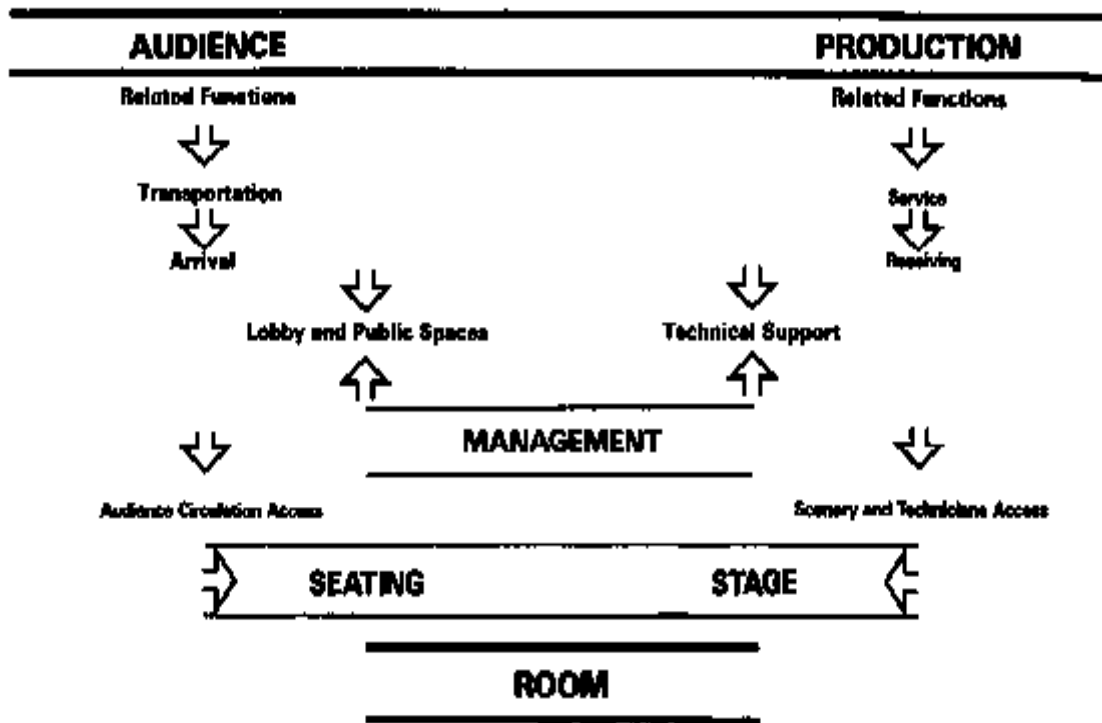

Figure 1

Room characteristics: external relationships

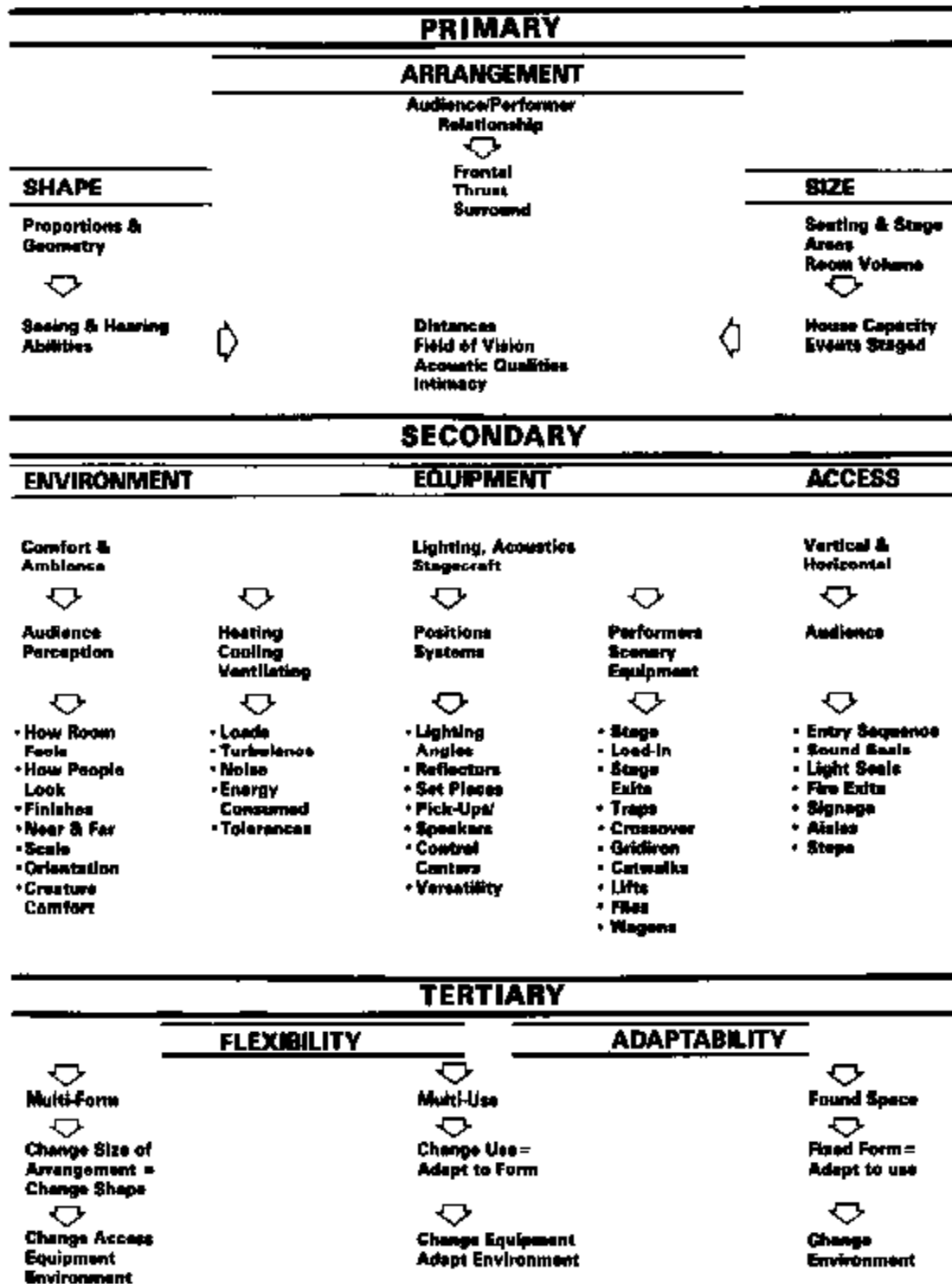

Figure 2
Room characteristics: internal relationships

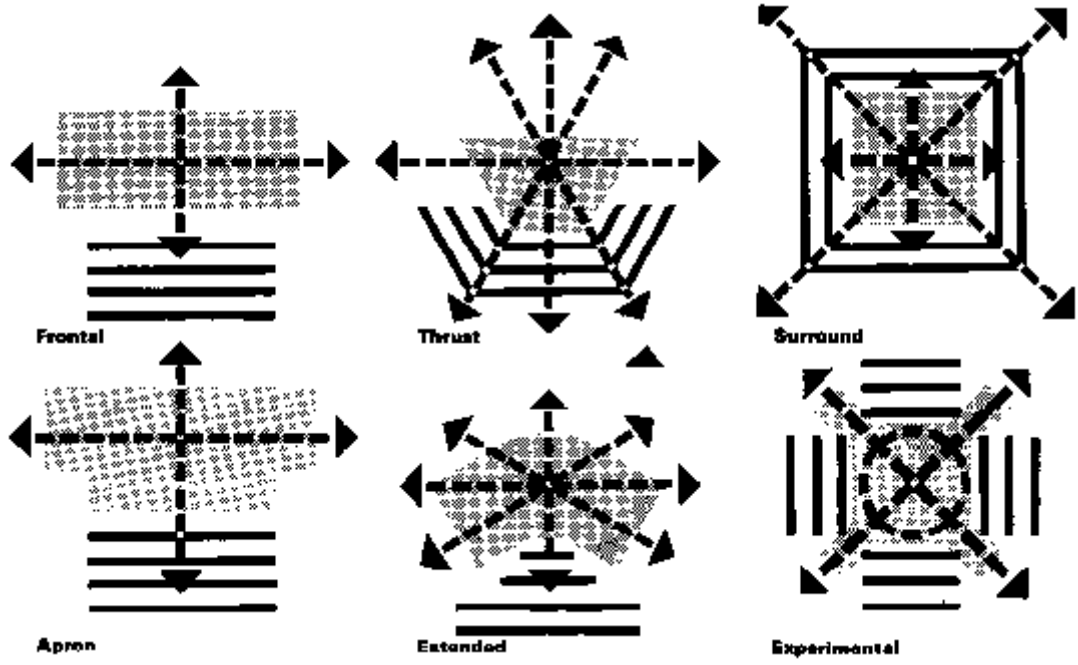

Figure 3

Audience – performer arrangements

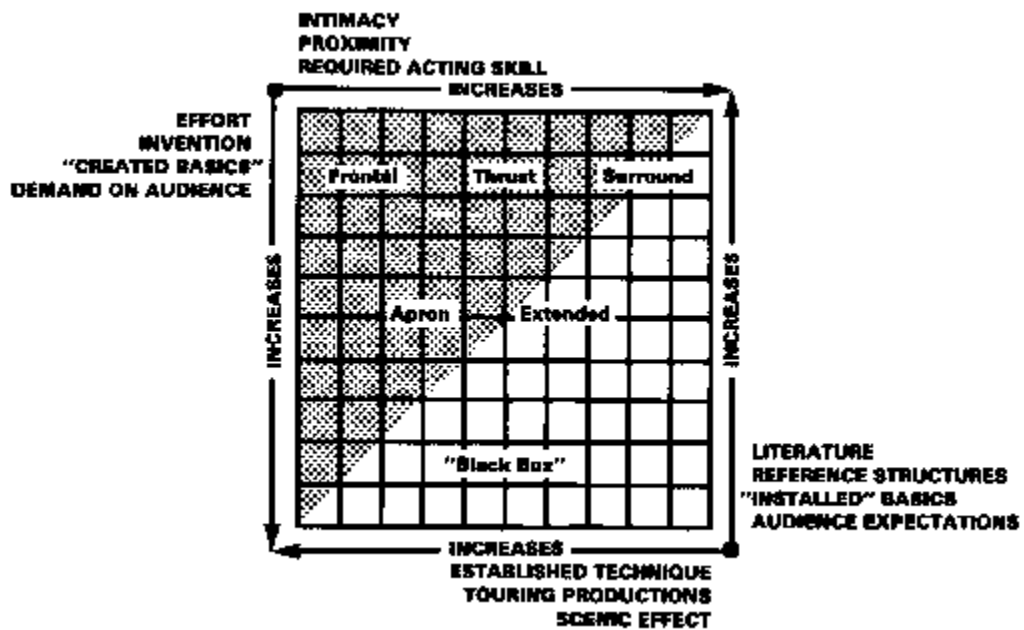

Figure 4

Room forms: probable choices

This guide will discuss three seating capacities as most likely choices for music and drama programs. They have been chosen primarily because they work well with established music and theater design criteria. The capacities are approximate numbers which can give or take 100 seats. Facilities may not necessarily conform to these three groupings. Smaller houses of around 100 seats have been developed as dinner theaters adjunct to a regular drama program. Generally, dinner theaters require more square footage per seat, plus considerable food service area. They are most successful when an intimate relationship between audience and performer is established by the arrangement of the Room.

Many existing 300-500 seat facilities are conversions of former 1000 seat movie houses. The 300 seat range appears most commonly at small installations where space for support facilities (Backstage and Front End) are at a premium.

At an installation having a 500 seat facility used for varying types of activities, the program director found that 500 works well for most legitimate drama, is too large for “serious” plays, and too small for musicals which consistently sell out.

2.3.3.1 300 SEATS. For technical reasons 300 seats represent a small legitimate drama house for a modest, local community audience. It offers economical production, which in turn encourages exploration and frequent turnover for varied experience and participation. Its concept is pre-professional or avocational involvement. A smaller house lacks "critical mass" to appeal to general audience interest and will find it difficult to justify the cost of equipment needed for a working plant.

2.3.3.2 650 SEATS. Because it verges on the limit of optimum vision conditions in a Frontal house, 650 seats represent a large legitimate theater. Of course, there are many larger commercial theaters. For music 650 corresponds to the smallest music house likely to be built as a singular facility. Smaller rooms are not ruled out, but they are technically limited to music forms, such as chamber quartets that comprise a very small portion of today's listening audience.

2.3.3.3 1400 SEATS. By American standards 1400-seats represents a large recital-ensemble room, or a medium capacity concert hall. Most recent symphony halls, partly for economic reasons, seat 2300-2500 (a practical upper limit for Frontal design with natural acoustics). While this design guide's emphasis of primary purpose Frontal form facilities of three capacities is intended to add clarity in a subsequent discussion, these "most likely" choices are also founded on functional and practical considerations. In general, the economic forces and institutional motivations at work in communities inevitably result in slightly different trends, toward large capacity multi-use stagehouse rooms and more modest open stage or non-Frontal theaters. However, basic design principles are similar. Unlike many privately sponsored performing arts facilities which develop over many years, some permanent MDC's are expected to be one-time capital expenditures, and completely operational on opening day. It will be advantageous to choose a theater design that provides today most of the physical plant and technical components foreseeable as future needs. The chance to add a stagehouse, orchestra pit or balcony, or to otherwise appreciably alter a permanent facility, is remote. In part, the design guide emphasizes the Frontal Room equipped with a flyloft because it utilizes (and illustrates) the most frequently desired hardware. In addition, there are many practical arguments favoring the proscenium theater/concert hall for communities. These considerations notwithstanding, open stage, Frontal, non-Frontal (Thrust or Surround) and adaptable configurations, may be appropriate choices in some cases. Later are outlined important differences in the use of an open stage, but its main feature is the substitution of movement, lighting and relatively portable stage pieces for the more traditional scenic investiture. A serious non-Frontal facility might be undertaken in response to a well-defined need in the community (for instance, if it already has a good conventional theater) or to a special set of program goals (such as minimal scenic repertoire and maximum role-playing development) or to unusual environmental factors (open air facilities, highly mobile installations, and inaccessible locations). An isolated community does not need to worry about attracting attendance, critical acclaim, or regular commercial road shows, but it could have an extra requirement for intimacy. A highly transient population would best use performance facilities designed for spontaneity and minimal production time.

There are two categories into which appropriate non-Frontal Rooms may fall: large scale and small scale. Operating elements must be manageable in number and complexity to yield the maximum range of variation. Whereas a small Room can contain a kit of many parts, a larger Room should have a few major devices by which it effects change when needed: the orientation, extension or dressing of the stage; placement of an orchestra enclosure or choral risers; preset lighting configurations; portable acoustic absorption or reflectors; and preset electronic sound reinforcement pattern.

2.3.3.3.1 LARGE-SCALE ROOM. The factor of scale makes inclusion of a large non-Frontal Room in the institutional context of a community necessarily a very deliberate choice. Scale has its impact in cost, quality of acoustics and visual environment, potential technical snags and conflicts, and the importance of seat-filling performance. Failure is magnified more than success.

2.3.3.3.2 SMALL-SCALE ROOM. The small-scale versions will probably be ‘alternative’ Rooms (that is Rooms in addition to a more typical facility) for the purpose of experimenting. Hence, these Rooms will be multiform spaces with readily transformed moveable seating and/or staging elements. There are doubtless similar exceptions to the seating capacities recommended by this guide. Existing theater facilities may not conform to these size categories, mainly due to constraints imposed by conversion of found space in repetitive (temporary) building stock. Smaller houses of around 100 seats have been developed as dinner theaters adjunct to a regular Drama program. Generally, dinner theaters require more square footage per seat, plus a considerable food service area. They are most successful when an intimate relationship between audience and performer is established by the arrangement of the Room.

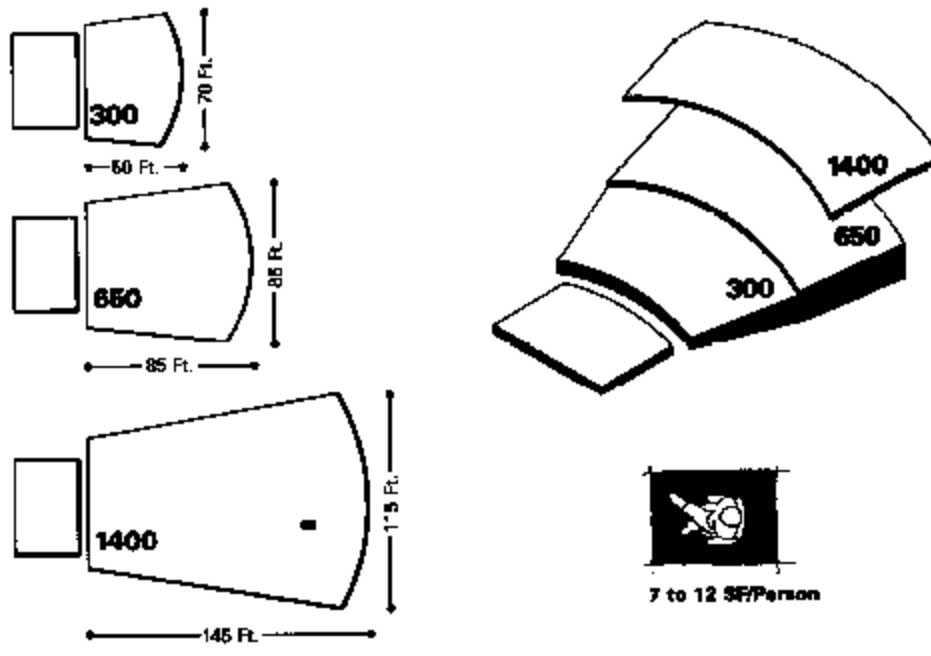

Figure 5
Capacity

Many existing 300-500 seat facilities are conversions of former 1,000 seat movie houses. The 10,000 sf movie theater ground plan may have been divided either to favor the Stage (with almost no audience support; say 1100 gsf) or the Front End (leaving only 2000 gsf for all stage functions.)

At an installation having a 500 seat facility used for varying types of activities, the program director found that it worked well for most legitimate drama, was too large for “serious” plays, and too small for musicals which consistently sold out. It is presently difficult to find cause for building concert halls within the performing arts program, which tends toward the popular (amplified) music of today. Possibly in the future changing tastes and education could alter this.

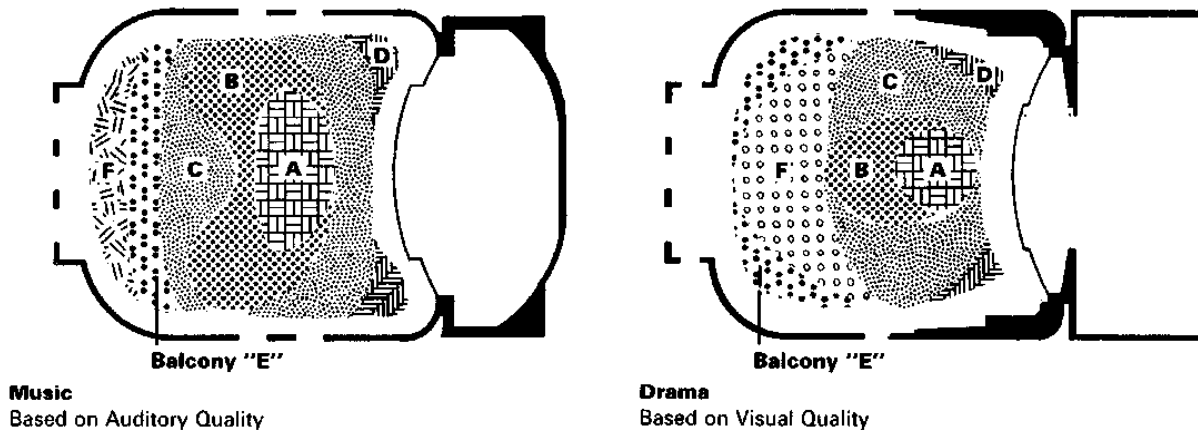

Figure 6

Audience seating preferences

2.4 ROOM QUALITIES. Performance is communication, and Drama Rooms differ from Music Rooms according to the medium of communication between performers and audience. Drama works with visual illusion, movement, gesture, and the articulation of spoken words. Music works with aural illusion, rhythmic patterns, tonal variations and subtle interactions of sound. In live performances, the give-and-take of communication relies on both vision and hearing, but each art form emphasizes one or the other. Desirable Room qualities vary accordingly. When these desired characteristics are followed out to their physical and functional implications, they describe different Rooms. The following two sections discuss the qualities of Drama Rooms and Music Rooms sought by audiences, performers, writers and composers. Naturally, descriptive language tends to reflect their separate viewpoints. The Room must assist performers to deliver, and audiences to appreciate, the full content and embellishment of the literature. Because many works are written with a specific theater configuration or acoustic character in mind, directors for a given Room may have to select or modify productions to suit it, or modify the Room itself. Between Drama and Music there are broad differences in the way quality is described. As long as the actors' speech can be clearly understood, vision qualities are the most important measures of Drama Rooms. For Music, the quality of sound is the dominant consideration. Good vision is easier to define in objective terms; the spatial relationships governing vision are relatively direct and geometrical. Good sound is a far more subjective impression. Human hearing combines direct and indirect sources,

responds to pitch and intensity in a non-linear fashion, and is affected acutely by the additional dimension of time. Analogies between the behavior of light and sound have been made to help describe subjective impressions, but these are inadequate for determining acoustic criteria and design guidance. The many similar terms that are used to describe both phenomena (color, warmth, clarity, tone, intensity, brilliance and intimacy) need examination and redefinition. This is the acoustician's specialty, no less a craft than stage and lighting design, involving variations of technique and conceptual inclination as well as science. An overview of important considerations is furnished next. It begins to suggest the functional priorities inherent in Drama and Music.

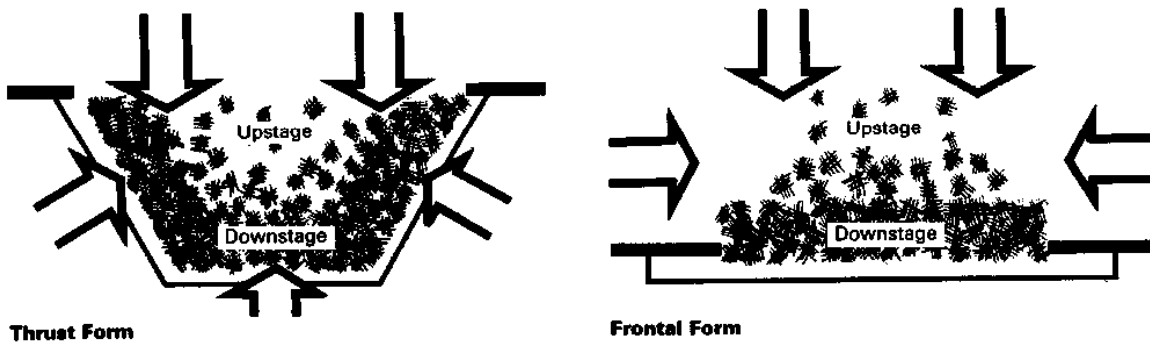

Figure 7
Acting Area Zone

3. DRAMA ROOM QUALITIES

3.1 VISION FACTORS. A Room built for Drama should enhance the special qualities of live performance that cannot be transmitted in film, video or printed media. Among these are continuity and individual control of viewpoint and the communication of spontaneous reactions, shared with others and registered on the course of events. Some of this is verbal byplay, but theater is a place where images become as malleable as words. Certain qualities of the Room lend facility to this purpose.

3.1.1 ABILITY TO SEE STAGE. The best Rooms permit a clear view of the entire performance area and surrounding scene space. On a Frontal Stage, the most critical vision field is downstage for the width of the acting area. However, the acting space must be seen in depth, too.

3.1.2 ABILITY TO SEE ACTION. A key element of Drama is movement, which is most readily perceived across the line of vision. For the Frontal form, this movement is basically side-to-side with respect to the centerline of the Room. A proscenium in the foreground is the major frame of reference, while scenic elements furnish context and scale. In the absence of a proscenium (open stage), action assumes an immediate, “in the same room” quality unless scenery and lighting contrasts are made to perform the proscenium function. For projected stage forms with no proscenium, action is perceived from several directions. In this case, perception of relationships among actors is critical and scenic material should not hinder vision. Dramatic and directors’ interpretations may place different stress on foreground, context, and background references. Within limits, the same literature can be adapted to different stage forms.

3.1.3 ABILITY TO SEE DETAIL. Dramatic performance emphasizes perception of actors’ expressions, gestures, and body movements. Perception of detail is related to viewing distance and angle of address. Distorted perspective, usually a result of close quarters, and foreshortening due to elevation of the viewer, should be avoided.

3.1.4 UNIFORMITY. This is a double-edged judgment of quality. Everyone should have a superb experience of the drama, but it will not necessarily be the same experience. If one assumes the artist's purpose is to communicate to the audience a specific image, the uniformity of what every viewer sees is a positive value. This concept of "uniform effect" is sometimes considered an advantage of a Frontal configuration, based on maximizing seats near the Room centerline. Obviously, factors of distance and vertical angle can be equally important. If the artist's purpose is to communicate with the audience, proximity and focus are also positive values. The quality of "intimacy" is more easily associated with the Thrust and Surround configurations that create the sense of audience and performers together in one space. A Frontal room can also be intimate, either because it is small enough to promote eye-contact or because the audience is aware it shares a mutual experience within the space.

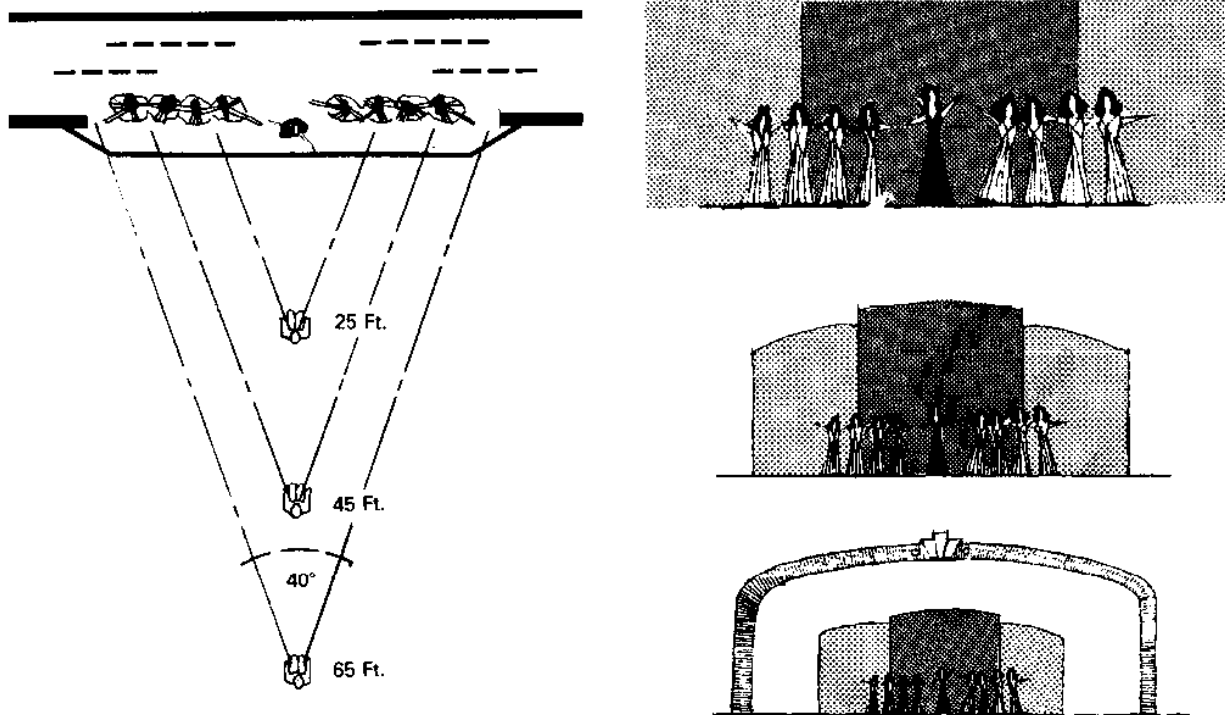

Figure 8
Distance and detail

Uniformity comes to mean that everyone has an equal chance for a fine experience in a Room that may offer a variety of viewing positions, none of which can be easily labelled “better”.

3.1.5 ACTORS’ ABILITY TO ORIENT. In the Frontal form, actors orient to the proscenium and/or stage set, and gauge their movements accordingly. The shape and arrangement of the acting area can also be used to differentiate regions within the world created by the play. When there is little scenic material, this definition of “place” assumes greater importance for both actors and audience.

3.1.6 ACTORS’ ABILITY TO SENSE THE AUDIENCE. Actors play to the audience. They need to see the audience response; this is another factor for audience proximity. Moreover, actors respond best to an apparently full house. The seating area should not be oversized; at least, its configuration should permit maximum use of near stage seating.

3.1.7 FUNCTIONAL TECHNICAL SUPPORT. Vision factors enter into placement and selection of accessory equipment. Lighting angles affect an instrument’s field of coverage and uniformity of intensity, while distance accounts for required power. Persons controlling these instruments need to see the action from an audience point of view. Offstage prompters need to be seen by actors, and unseen by audience. Pit musicians need to see the conductor, who in turn must coordinate their efforts with the action on stage.

3.1.8 OVERALL INFLUENCE OF VISION FACTORS, DRAMA. Geometric and psychological aspects of vision determine many point-to-point relationships in the Drama Room. Vision criteria are essential to setting the dimensions and positions of floor planes on which the audience sits, points in space where equipment is mounted, and the location of the proscenium and stage dressing all in relation to the acting area.

3.2. HEARING FACTORS. For Drama, the implications of hearing criteria are less complex than for Music, but qualities discussed here are important to Drama.

3.2.1 ABILITY TO COMPREHEND SPEECH. Articulation and intelligibility are essential. The actors' voices should not be garbled by reverberations and echoes.

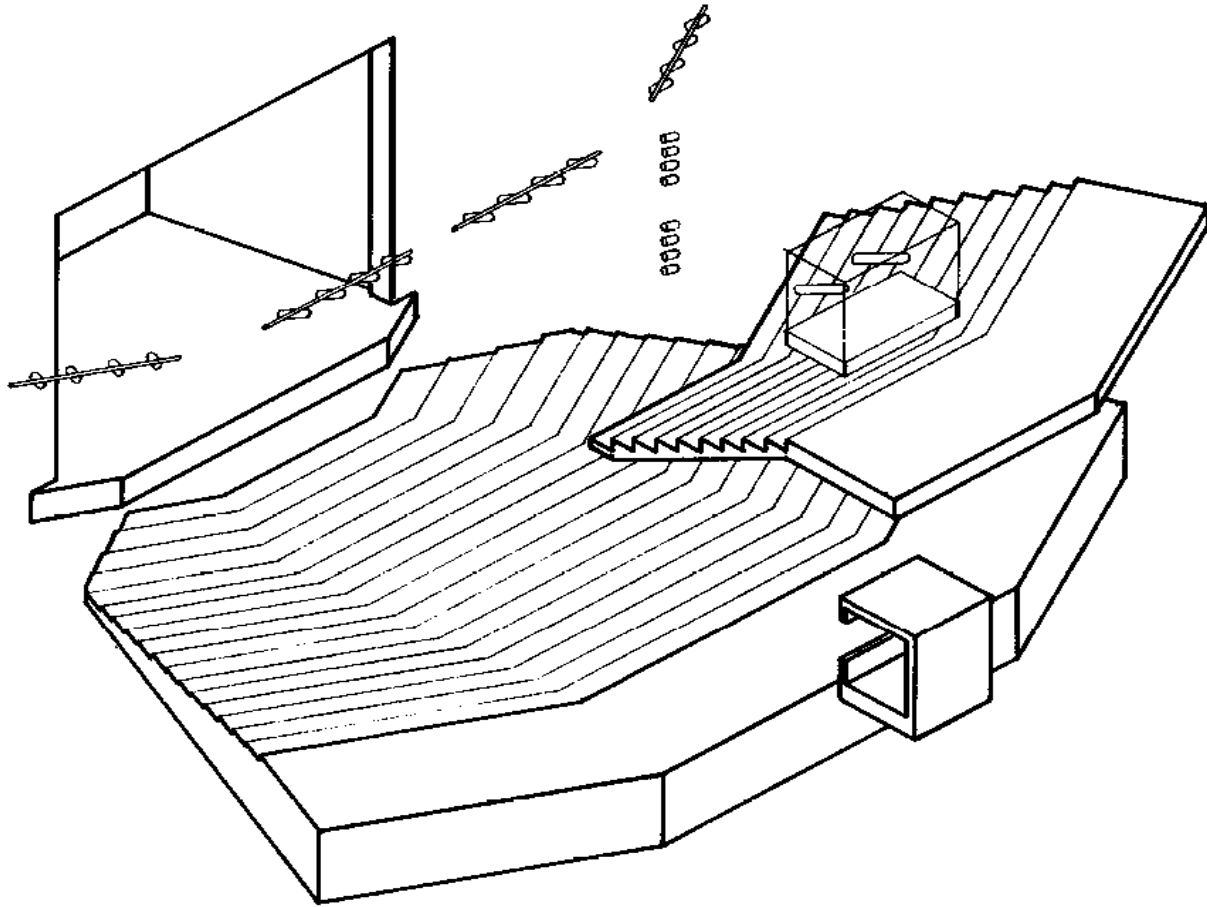

Figure 9

Drama Room – shaped for vision

3.2.2 ABILITY TO HEAR. Speech sound levels must be high in every part of the house relative to the background noise. The human voice is not especially powerful as a source without careful training, but the discriminatory powers of the ear are amazing. Forced loudness is immediately discernible as unnatural.

3.2.3 FREEDOM FROM DISTRACTION. While continuous noise sets the level against which speech is heard, isolated and unrelated sound events and discontinuities in noise levels draw attention to themselves and constitute distractions and annoyances.

3.2.4 CONGRUENCE OF ACTION AND SOUND. Both our ears and our eyes possess directional abilities. If our ears and eyes disagree about directions, we get uncomfortable. Similarly, the nonsimultaneity of observed action with perceived sound can be disturbing. Dramatic impact often depends on close timing and convincing sound effects.

3.2.5 ABILITY TO ASSESS PROJECTION AND HEAR CUES. Actors have hearing requirements, too. They need to hear cues in order to coordinate actions. They also need to estimate the intensity of voice perceived by the audience. Hence, relative sound levels and qualities should be the same on stage and in the house.

3.2.6 ABILITY TO MODULATE ACCOMPANIMENT. Musical accompanists need to hear the principal actors or singers in relation to their own sound production as the audience hears it. At the least, the conductor must be able to coordinate musical accompaniment with other sounds leaving the stage.

3.2.7 ABILITY TO ADJUST SOUND LEVELS. Technicians must hear what the audience hears in order to adjust artificially produced sound levels, or to signal actors or musicians if an imbalance occurs.

3.2.8 OVERALL INFLUENCE OF HEARING FACTORS, DRAMA. Hearing requirements set up criteria for reverberation, ambient noise levels, sound intensity, time delay and directionality that in general will be shown to relate to details of the Room's enclosure and boundary surfaces. Hearing factors also influence pit and stagehouse design, control locations, and sound system criteria.

3.3 OTHER FACTORS. Some desirable Room qualities stem from functional needs that have more to do with ease of use, economy, comfort and safety than with the performance experience. These have been called secondary and tertiary considerations to denote the order of treatment.

3.3.1 EQUIPMENT. Lighting, rigging and scene handling activity involve a great deal of physical mobility during the performance and its preparation, but it must not impinge on or distract from the performance. Also, the design and location of this equipment in turn influences Room configuration, building structure and power system design. Equipment quality refers to usefulness and sufficiency in application. Quantities of equipment can be rented when needed, but the basic systems must be completely thought out to anticipate a range of circumstances. Poor equipment limits production choices.

3.3.2 ACCESS. Moving scenery and people on and off stage in various ways before and during performance is no small feat. Lighting and rigging equipment requires technicians' access for adjustment, control and maintenance in place. Moreover, the need for safe and efficient audience entry and exit paths will affect the house layout. These all have direct consequences in physical form. Access quality is judged by the ease and efficiency of its accomplishment. Poor access can limit production choices and lengthen production time. It can also prohibit adjustment of house capacity and arrangement.

3.3.3 ENVIRONMENT. Heat generated by lighting equipment and an assembled crowd must be dealt with by an air conditioning system that does not hinder performance activities, create noise and draft, or obtrude on enjoyment of the drama. Environmental systems should readily adjust to varying demand. Environmental quality is measured by the absence of discomfort. A poor system can restrict audience size and stagecraft techniques employed. It can also be expensive to operate in the long run.

3.3.4 FLEXIBILITY. The ability to use the Room in different ways is to some extent proportional to the magnitude and flexibility of equipment systems. However, reliance on equipment can be a limiting factor and very expensive, if the equipment is not planned as an accessory to the Room itself. Flexibility is evaluated as the ability to accommodate anticipated uses, not just any use. This means providing the Room qualities for each use, some of which imply unchangeable concrete decisions that will rule out options for other qualities. The basic choice of arrangement must be made in anticipation of multiple uses. Poor planning for flexibility, results in facilities that are not especially good for anything. If

a Drama Room is to be used for Music, it will be easier to adjust for the vision factors than hearing (acoustic) qualities. Without sophisticated electronics, the Multi-Use Drama Room has distinct limitations in this regard.

4. MUSIC ROOM QUALITIES

4.1 HEARING FACTORS. A Room built for Music is intended to add to the sounds experienced, just as the Drama Room adds light, color, movement and continuity. We cannot define why music is pleasurable, but there are qualities of live performances that cannot be recorded and reproduced elsewhere; every space adds its characteristic stamp to the sound generated in it. Musicians adjust their technique in response to what they see and hear, and listeners are caught up in the continuing improvisation, making for a fuller appreciation of subtle variations and combinations. Observation reveals certain qualities that enhance this experience.

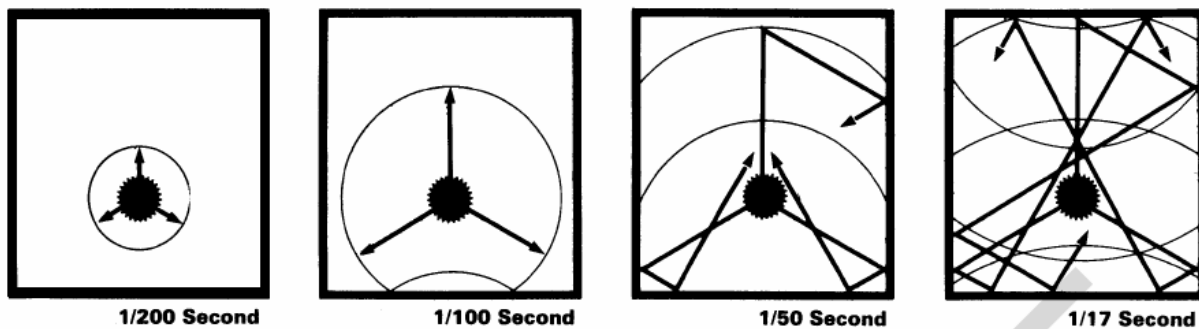

Figure 10

Sound wave in enclosed space

4.1.1 ABILITY TO HEAR ALL LEVELS OF SOUND. This is sometimes generalized in terms of the dynamic range of music that can be heard in the Room. It is evaluated in terms of loudness, or the strength of sound perceived by the listener and the evenness of this characteristic ranging from the quietest (audience noise) to the strongest fortissimo that does not produce discomfort. Loudness in music listening is a complex subjective measure. We hear the sound issuing directly from the performer and its reverberations in the Room as “one sound” unless something is very wrong acoustically.

4.1.2 APPROPRIATE REVERBERATION. An important measure of Music Room fitness is decay of reverberation over time, or the persistence of audible sound after its source has stopped. Normally, two to three seconds elapse. Like loudness, reverberation time is

not a simple measure. One Room's reverberant characteristics will differ from another's and the pattern will also differ with musical pitch. Thus, as the liveness also contributes to dynamic range, dynamic range can be one guide to how well a given piece of music or collection of instruments will be heard. In terms of loudness, reverberant characteristics are clues to tonal qualities and the styles of music that will sound "right". Composers write music with the reverberant environment in mind, be it a cathedral, recital hall or parade ground.

4.1.3 ENHANCEMENT OF MUSICAL QUALITIES. Subjective opinion, comparison with familiar models, education of the ear, and individual preference all enter into the judgment of what makes one Music Room better than or different from another. The acoustician, musician, and critic do not lay claim to a precise science, but to observable phenomena. Rooms that are judged good from these viewpoints have been carefully examined for consistent evidence. As a result, acousticians have gathered a better understanding of how subjective impressions are formed and the conditions that produce them.

4.1.3.1 THE RELATIONSHIP OF DIRECT (SOURCE) SOUND to reverberant (reflected) sound influences many of the subjective impressions of quality. Loudness of direct sound falls off with distance and is affected by the design of the stage and its surrounding surfaces. A portion of this sound strikes reflective surfaces and reverberates, losing energy as it travels and bounces. Loudness of reverberant sound therefore falls off in proportion to the amount of absorptive materials (including people) in the Room and to the fraction of direct energy that does not go straight to the listener. In a small Room, the direct/reverberant ratio is high, and the reverberation time is short. Music sounds dry, sharp and even clinical. Increasing the volume will lengthen reverberation. Altering the "sending end" can increase the portion of sound directed into this volume, versus that sent the listener. So doing results in a "fuller" tone.

4.1.3.2 TONAL QUALITY is a judgment of what the Room adds to or subtracts from the sound. "Brilliance" refers to enrichment of high frequencies relative to mid-frequencies. "Warmth" refers to fullness of bass tones. The reverberation time for mid-frequencies is

the primary reference for these qualities and the measure of a Room's "liveness". "Definition" and "clarity" describe how distinctly sequential and simultaneous sounds are heard. It is a function of reverberation time, direct/reverberant loudness, and blend. "Balance", the perceived relationship among sections of the orchestra, and "blend", the harmonious mixing of instrumental voices, are related to the disposition of the players and the design of the stage enclosure. "Intimacy" or presence is what we hear in a small Room. Our impression of a Room's size is determined by the time interval between hearing direct sound and its first reflection. Moreover, the direct/reflected loudness ratio must not be too small.

4.1.4 MUSICIANS' NEEDS. Musicians are sensitive to the ability to hear themselves. Two qualities are important: 'ensemble", ability to hear others and play in unison, and "attack", the immediacy with which first reflections return to the musician, and by which he may gauge the effects of his playing. Both are functions of the stage enclosure and nearby portions of the Room.

4.1.5 ABSENCE OF ABERRATION. Exaggeration, or lack of any valued quality, is an aberration. The worst aberration is echo, a longdelayed and sufficiently loud reflection that can be distinguished by the ear as a separate impulse. Geometric focussing intensifies echo. Since the size of a given surface can selectively reflect certain wavelengths, particular frequencies may be concentrated at a point resulting in the perception of a sudden intense slap. Near-parallel surfaces will produce a flutter echo. Standing waves arise between parallel surfaces spaced at a multiple of one-half the given wavelength. A continuous tone will cancel itself at one point and double at another.

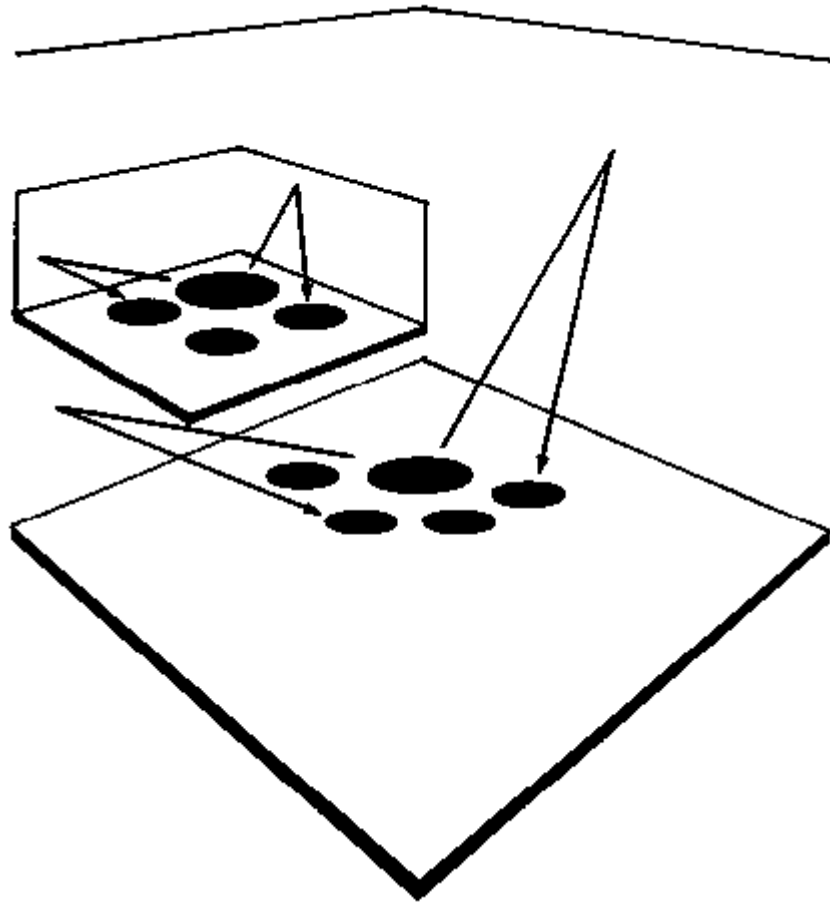

Figure 11
Intimacy

4.1.6 LIMITING OF NOISE. Noise can originate within the Room or outside of it. Continuous noise generated within the Room by the audience and mechanical system operation forms the reference baseline of perception and dynamic range. Intermittent noises louder than this ambient level are annoying. Acousticians have developed empirical standards called preferred noise criteria (PNC) curves for various listening activities. External noise is to be eliminated. The construction that retains sound energy in the Room generally excludes only air-borne noise. Sound can be transmitted by a structure as well as by air. Hence, either the noise or the structure must be isolated.

4.1.7 FITNESS TO PERFORMANCE TYPE. Music types have varying properties and are intended to be heard in specific acoustic environments. A high degree of reverberant fullness is important to romantic works, while contemporary and chamber music profit from definition. Small orchestras and soloists emit less energy and should be heard in small Rooms. The composition of a marching band is designed for field house and parade ground. There is no average, all-purpose Music Room. It must be matched to the music intended to be heard. If the Room does nothing to enhance the listening experience, a good electronic playback system is preferable; at least people don't risk disappointment that way.

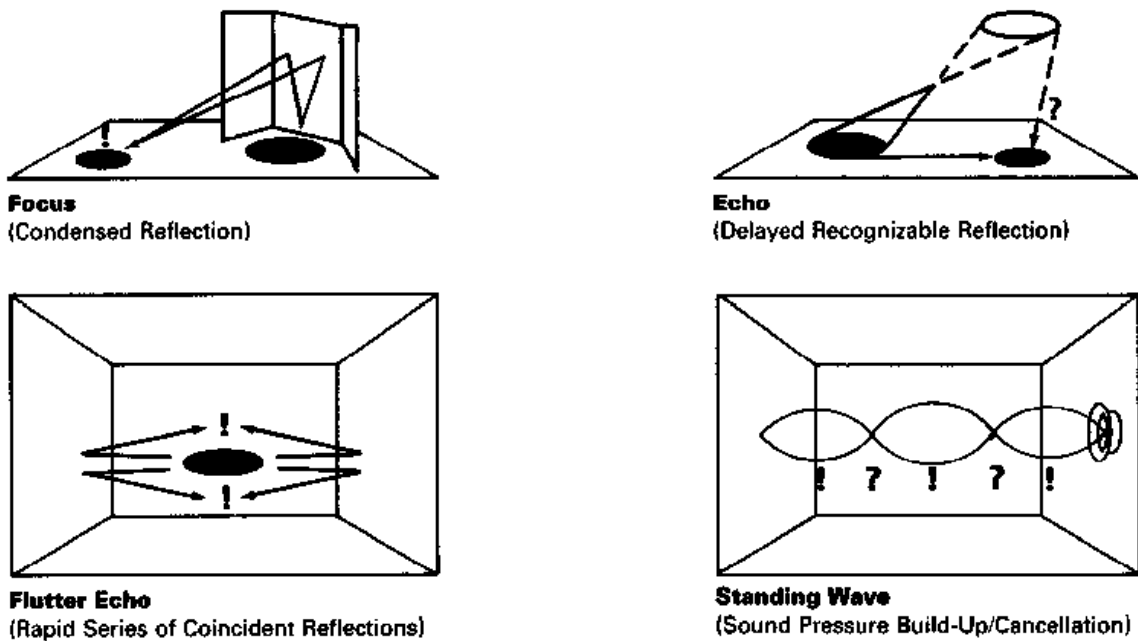

Figure 12
Abberations

4.1.8 OVERALL INFLUENCE OF HEARING FACTORS, MUSIC. Hearing (perceptual) and acoustic (physical) phenomena determine many of the desired characteristics of the Room enclosure and boundary surfaces, proportions, volume, materials, and connection to the external world.

4.2 VISION FACTORS. For Music, the influences of vision criteria are similar to those for Drama, but less crucial to success. Direct functional relationships dominate.

4.2.1 PERFORMERS' ABILITY TO READ MUSIC. Musicians are constantly looking away from the score and back again. For rapid accurate reading illumination levels, angles, evenness and relative contrast must be carefully controlled. Adequate space is needed to arrange awkward instruments and shared music stands.

4.2.2 ABILITY TO SEE EACH OTHER. Arrangement also permits needed eye contact among musicians and easy view of the conductor. Its importance increases when soloists or dancers are involved.

4.2.3 ABILITY TO SEE THE AUDIENCE. The best performance is one in which performers and audience respond to each other. Again, relative illumination and arrangement are important. Moreover, musicians are sensitive to the Room's ambience, its color values, and its "woodiness" (statistics show).

4.2.4 FUNCTIONAL TECHNICAL SUPPORT. Broadcast, recording, sound reinforcement and lighting technicians need to see performance activity, preferably as the audience does.

4.2.5 AUDIENCE ABILITY TO SEE MUSICIANS. The finest sound reproduction system cannot duplicate the experience of a live concert's extra dimensions of anticipation and participation.

4.2.6 ABILITY TO READ AND NAVIGATE. Total absorption in performance is not characteristic of music audiences. In the absence of spoken narrative, reading the program notes adds to enjoyment and comprehension. Of course, listeners have to find their seats, the coatroom, restrooms, etc.

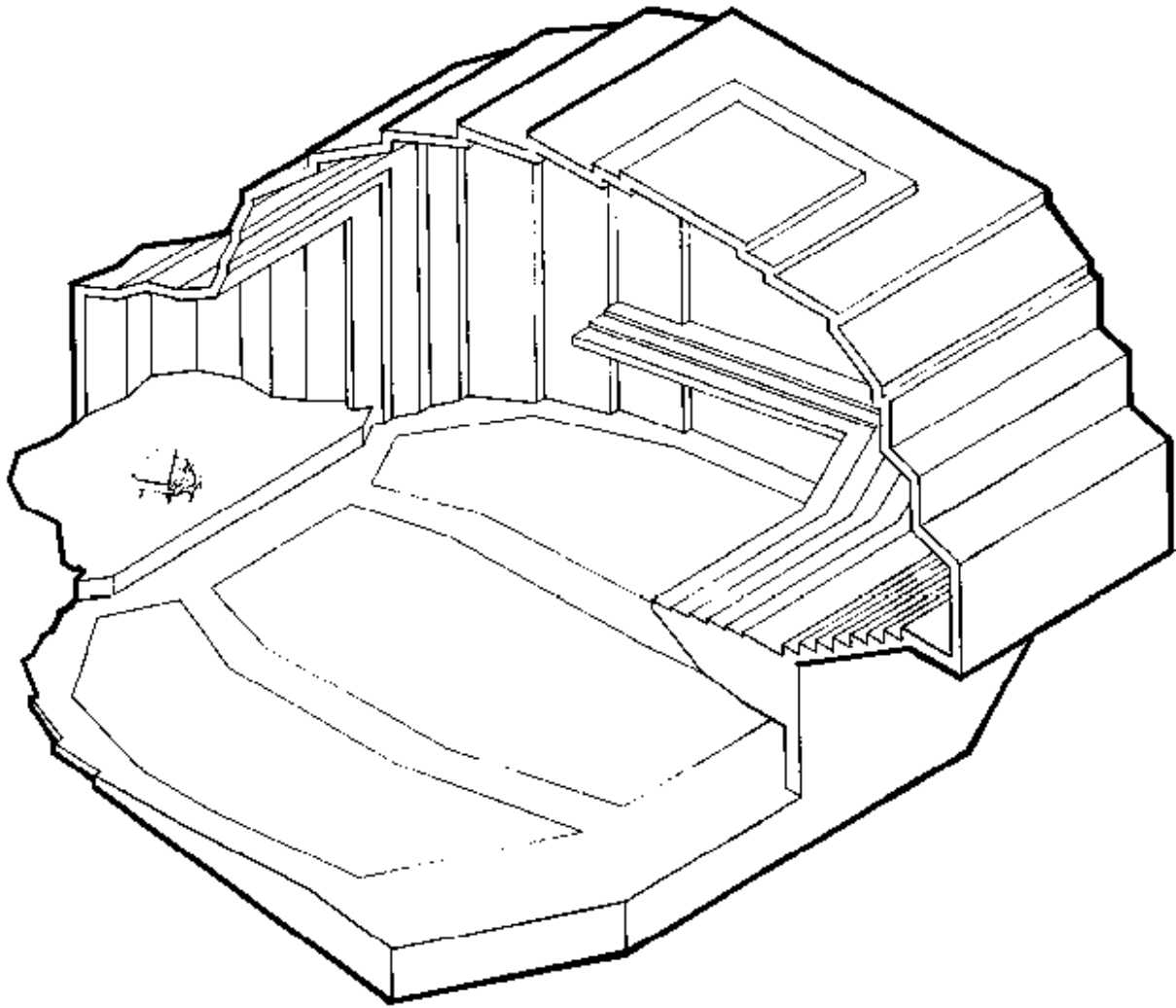

Figure 13
Music Room shaped for hearing

4.2.7 PERCEPTUAL PSYCHOLOGY. Room ambience is a description of how people look in terms of color and modeling of features. It is also how the Room looks in terms of color and “drama”. Concert lighting is relatively simple. Since there is usually little movement, lighting shifts add interest and relative brightness focuses interest.

4.2.8 OVERALL INFLUENCE OF VISION FACTORS, MUSIC. Vision parameters mainly affect illumination, room finishes and arrangement of performers functionally. Physical design “improvements” for sight lines should be carefully weighed against potential ill-effect acoustically.

4.3 OTHER FACTORS. Four other factors have qualitative impact on Music Room design. Brief comments below indicate the emphasis regarding Music criteria.

4.3.1 EQUIPMENT. Accessory equipment for Music is typically less extensive in quantity than for Drama, but since it is most often custom made to suit specific needs, it is also more costly to replace. Therefore good built-in permanent equipment has real value. All theatrical equipment is subject to high standards of construction and installation to limit noise generation.

4.3.2 ACCESS. There must be access to the stage for piano, chairs and stands, musicians and risers. Providing a suitable number and size of openings can affect the design of the orchestra enclosure. Doors, for audience access and egress, should be limited in number and carefully sealed to reduce sound loss and noise intrusion.

4.3.3 ENVIRONMENT. Since the audience is relatively sedentary, noise criteria are more stringent. Temperature and humidity stability are extremely important to maintaining musical instruments in tune. House lighting levels are slightly higher than for Drama.

4.3.4 FLEXIBILITY. In general, the ability to use the Room for different music presentation types depends a lot on repositioning sound sources (musicians) in relation to surfaces near them. These surfaces can themselves be adjusted, but physical alteration of the enclosure should be undertaken with restraint, under supervision of a knowledgeable acoustician.

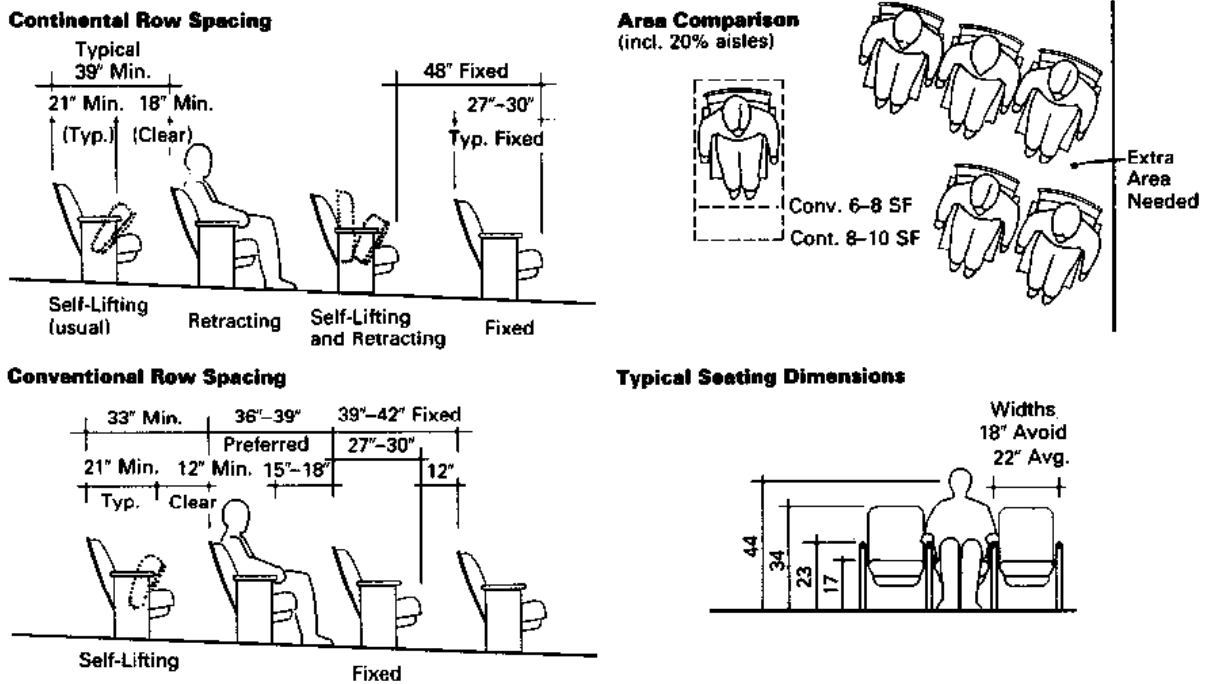

Figure 14
Seating area units

Flexibility refers to the conditions favorable for various music types, not strictly the number of musicians on the platform. Favorable conditions can often be accomplished by relatively small changes in several parts of the Room, balancing the type of music, number of musicians and size of the audience. If a Music Room is to be used for Drama, it will be easier to adjust acoustic conditions than vision criteria. The Multi-Form Room concept is the most impractical for Music.

5. THE HOUSE. The House is one half of the Room. Investigation reveals two general concepts about it. Vision criteria, the major organizing principles of Drama uses, define the distribution of people in the House, while hearing-criteria, the major organ organizing principles of Music uses, define the distribution of boundary surfaces. Second, varying the size of a Drama audience mainly influences the linear and planar geometry of the House, while varying the Music audience mainly influences volumetric geometry. In this section, Drama (vision) and Music (hearing) considerations will be applied to the audience portion of a Room, in terms of the primary attributes of size, shape and arrangement. The effect of varying house capacity will be studied, but variations in the form of presentation will be addressed in discussion of the Stage. For now, a Frontal arrangement is assumed: either legitimate drama or orchestra on stage. Details and technical data will be treated in succeeding sections as appropriate.

5.1 DRAMA HOUSES.

5.1.1 SEATING AREA DIMENSIONS. The number and arrangement of seats defines the net floor area of the House (an aspect of size). Reckoning of the area includes allowance for aisles and varies from 6 to 10 square feet per seat. Generally, a figure of 8 s.f. is good for first estimates although a higher number is usually needed for smaller capacities. This variation is caused less by differing seat dimensions than by conditions of arrangement. Sharp radius curves and ragged aisles introduce triangular residual areas. If seating is moveable, additional allowance must be made for imprecision and maneuvering clearances (13 to 15 s.f. is commonly used). To assure a speedy exit in emergencies, conventional seating usually limits row length to seven seats accessible from one aisle or fourteen from two, with rows spaced not less than 33". Row spacing must be greater for continental seating, which is practically unlimited in row length. Continental seating requires wider end aisles with closely spaced exit doors. It also gives more legroom seating, but more interference from latecomers. It also heightens the sense of vastness in a large Room. On balance, the floor area per seat is the same for both methods.

5.1.2 PLAN ARRANGEMENT WITH RESPECT TO STAGE. Vision criteria define the horizontal proportions (plan shape) of the Room with reference to the stage configuration and proscenium width. The dominant side-to-side movement on a Frontal stage places value on proximity to the Room centerline, while the desirability of short viewing distance works in the other direction. The objective logically should be to maximize the number of seats in the center front region.

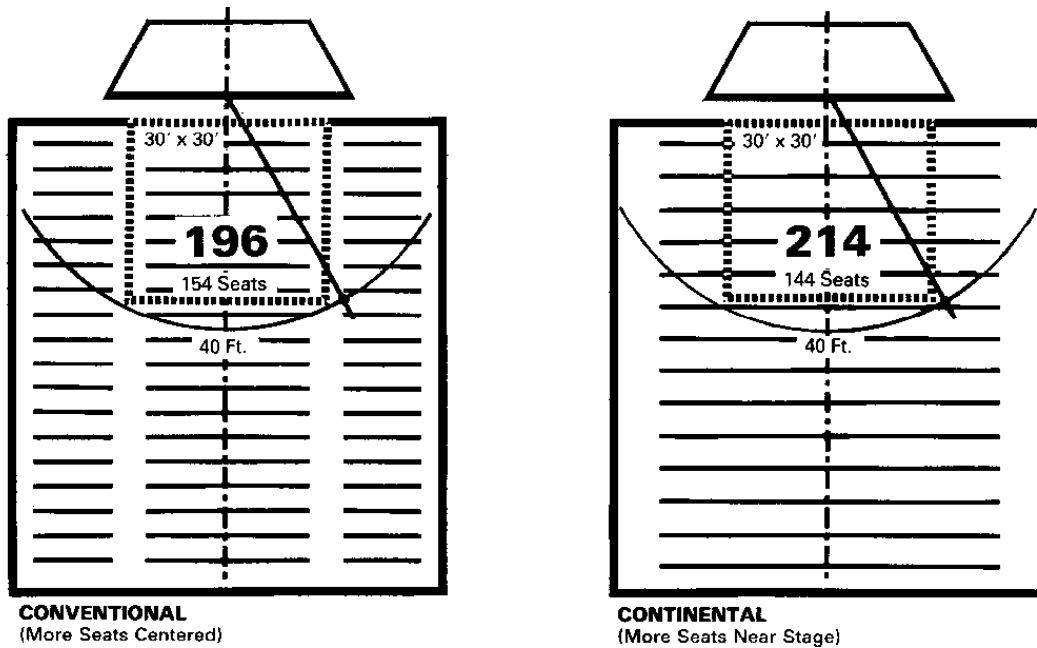

Figure 15

Conventional versus continental seating

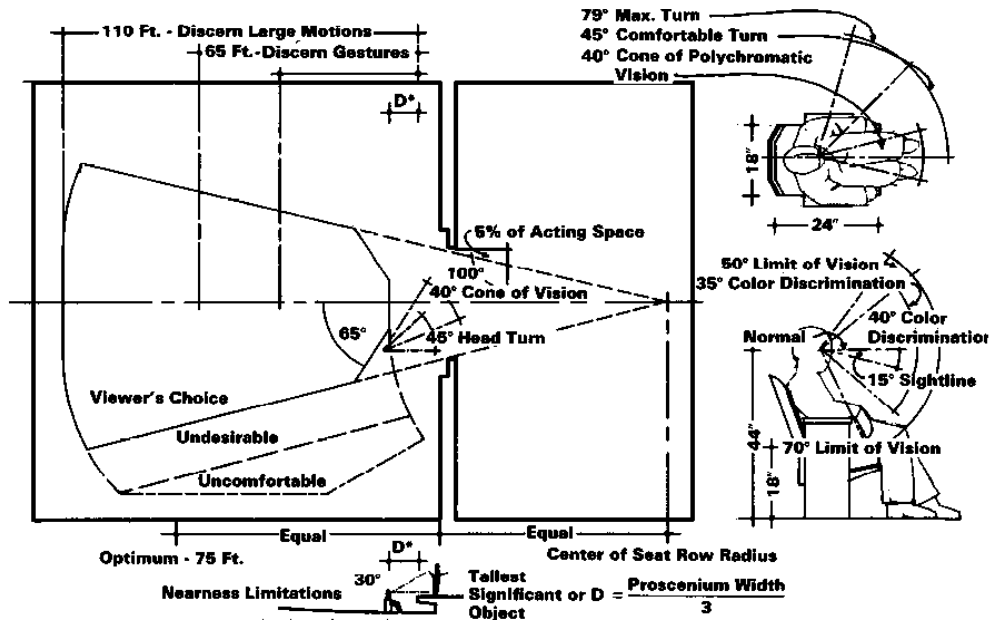

Figure 16

Plan definition of frontal seating

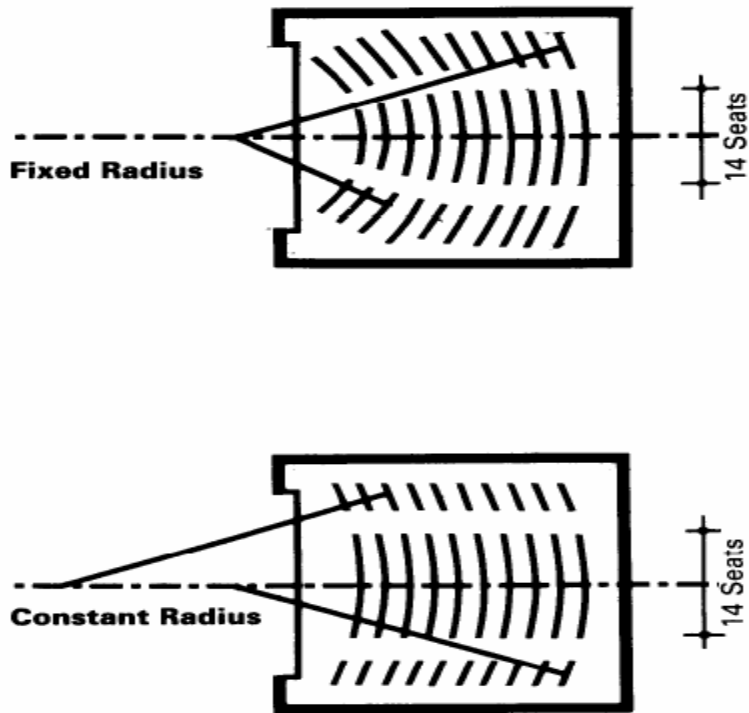

Figure 17

Plan Curvature

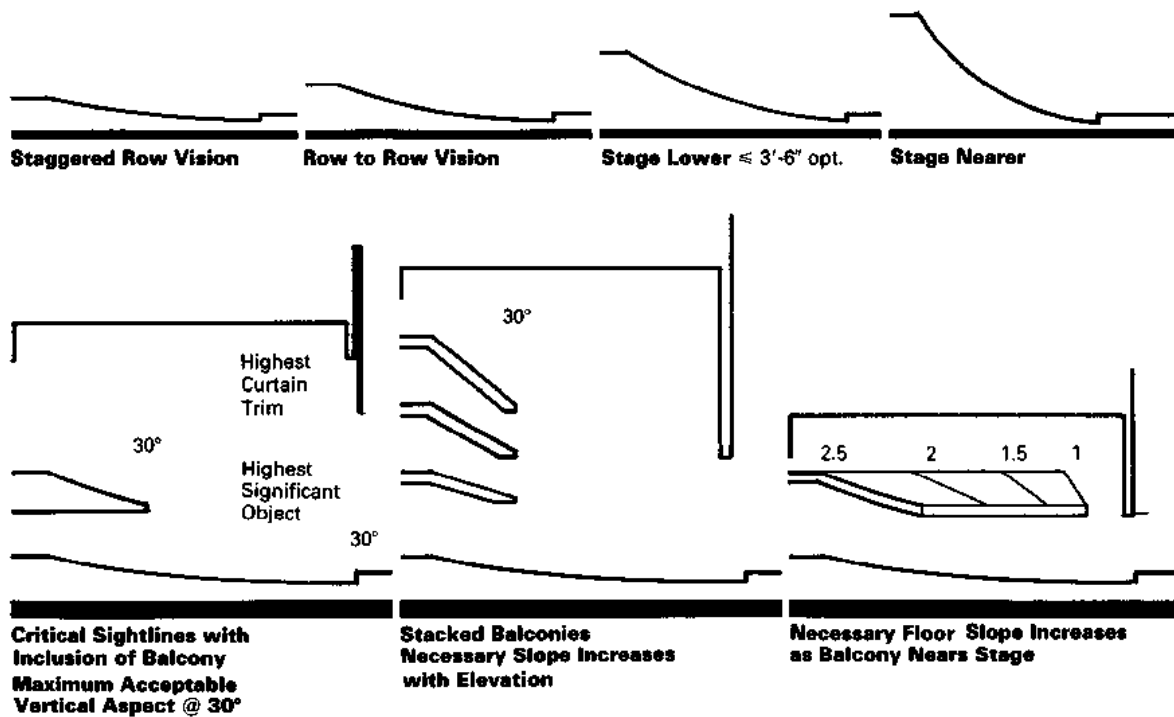

Figure 18

Floor slope – sightline relationship

Actors' expressions are difficult to see beyond 40 feet, gestures past 65 feet, and only large body movements can be seen between 65 and 110 feet. Location of drama audiences should be within 65 feet, if possible. Viewing at an oblique angle foreshortens the image and may require neck craning. The normal cone of optimum vision covers 30 degrees vertically and 40 degrees horizontally. Viewing angle works against front corner seats, which have the most oblique view from which portions of the acting area may be obscured. For that matter, any "front row" seat requires a lot of head movement to take in the entire acting area. A 45 degree pivot is considered a maximum tolerable exercise. The intimacy of Drama is enriched by focused orientation. Curved rows reinforce the impression of uniformity by centering attention. If the center point of curvature is on stage, the nearest rows are sharply arched. But the longer the radius, the less appreciable its effect. If conventional seating is employed (with longest rows of 14 seats), the radiating aisles eliminate a number of near-center seats. An alternate conventional plan places a cross aisle nearer the stage, which eliminates seats within the optimum vision distance.

Continental seating avoids these radial geometry issues entirely. Curved rows of gentle arc can have an identical radius with the focus somewhat reduced, but allowing uniform, maximum row length and flush aisles with conventional seating. This “rectangular” arrangement requires varied seat unit size in order to provide staggered seats from row to row. Staggered seats permit one viewer to see between heads in the next row.

5.1.3 VERTICAL ARRANGEMENT WITH RESPECT TO STAGE. Sight line criteria in the vertical dimension help define floor slope (an aspect of sectional shape). Flat-floor Rooms are limited in capacity by the problem of seeing past a few rows of people. A straight rake (ramped) floor improves conditions for a short distance only. With each successive row, the steepness of the slope must increase in order to accomplish the same geometric sightline clearance from row to row; ideally 5 or 6 inches would be required for every two rows if seats are staggered. The relative stage level is a factor here; a lower stage favors a steeper floor. Since concern for comfort and safety limits the maximum ramp slope and discourages single risers in aisles, a limit is applied for the number of rows before a cross aisle or other device breaks the pattern. Where steps are necessary, they should be between 4½" and 8" high and clearly marked or illuminated. Aisle slopes should not exceed one foot in eight. Rising curvature is a difficult construction condition. When compounded with horizontal radii, a “dish” or “teacup” is formed. Converging aisles become a necessity, which for safety reasons, should run in the direction of slope. Dished floors present slight disadvantages in terms of adaptability to other arrangements. If level terraces are desired on a temporary basis (dinner theater or experimental forms) no section of infill platform is alike. A constant radius or rectangular plan is more easily adaptable at some expense to intimacy of focus.

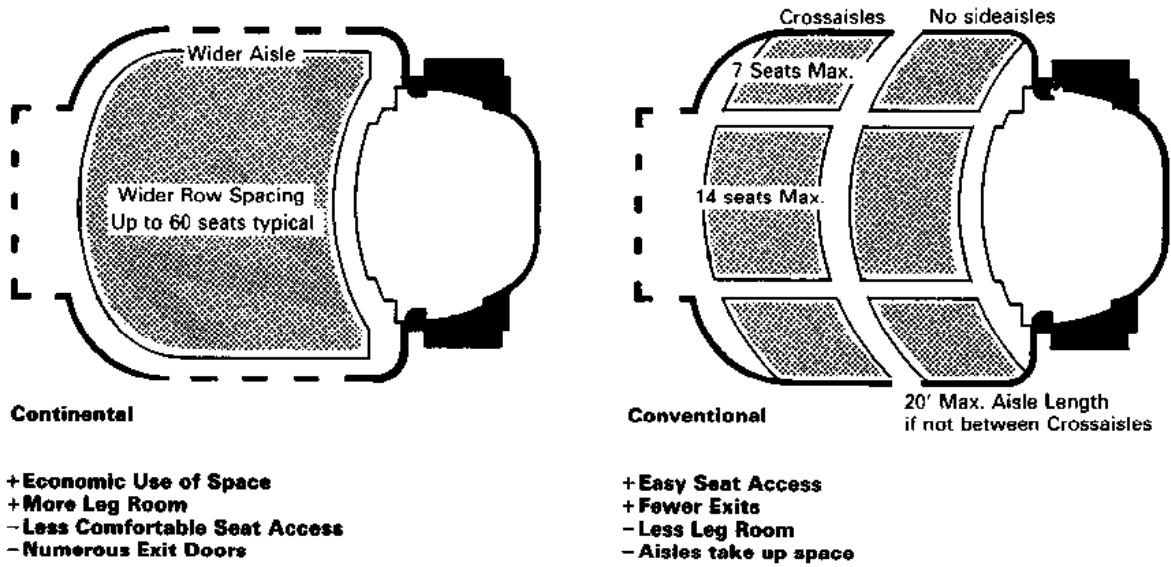
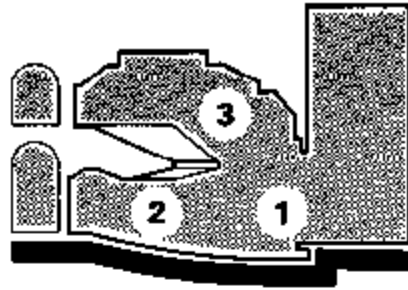
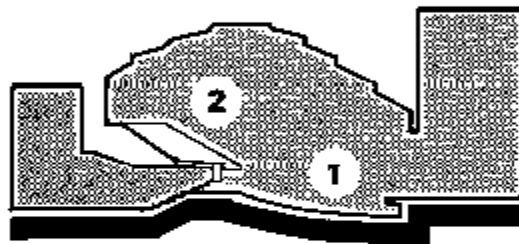

Figure 19
Large house problems



Balcony: 3 pieces



Ledge: 2 pieces

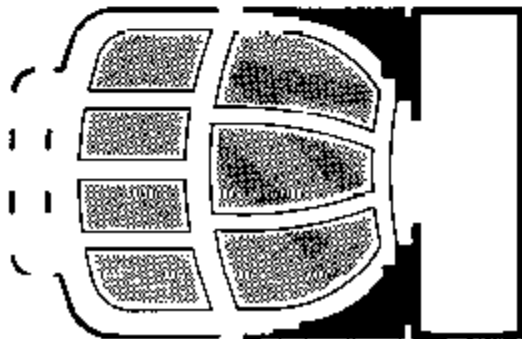

Berry Patch

Figure 20
Larger house subdivisions

5.1.4 THE LARGE ROOM. Special problems are associated with size increase, including the impression of scale conveyed by a sea of people. It makes the performance seem more remote, the individual less important, the experience less intense (aspects of arrangement).

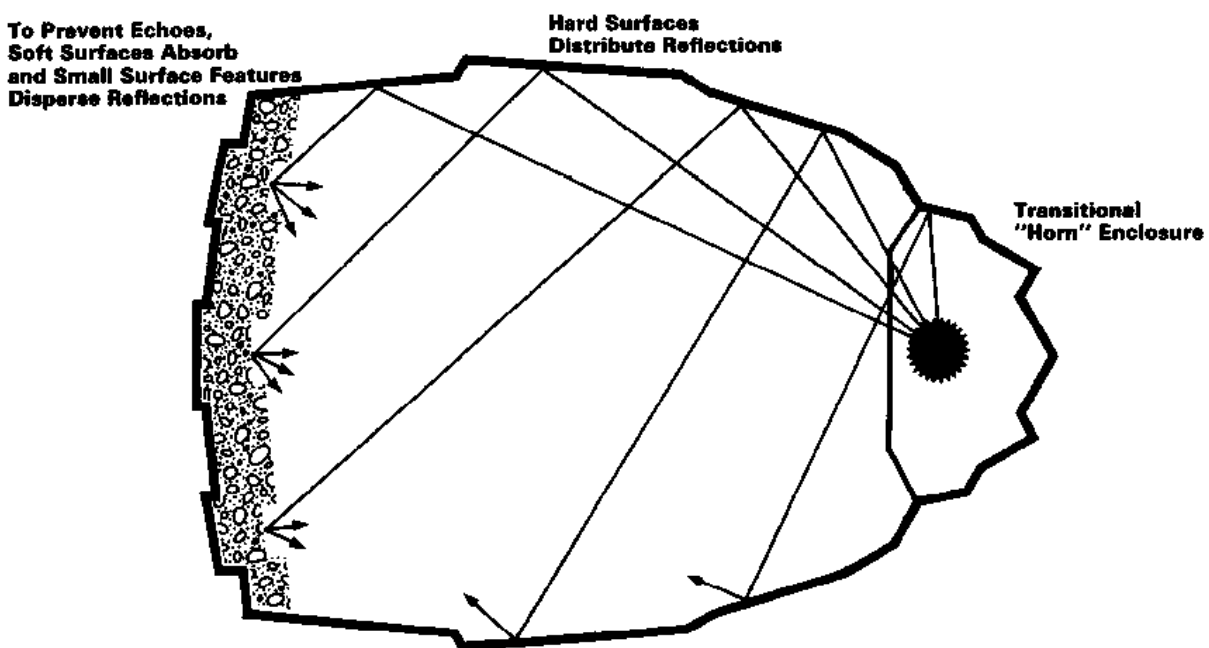
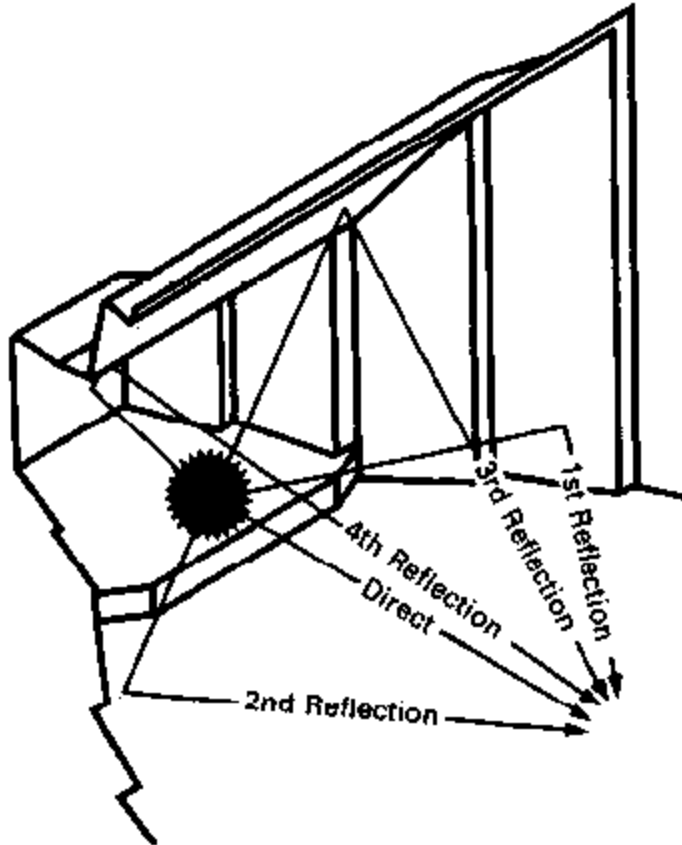

Figure 21
Larger house subdivisions

Continental “wall-to-wall” seating can heighten this impression, although it is more efficient at large capacities because cross aisles are not needed. Nevertheless, aisles do help define smaller units of seating, which may make the Room seem smaller. As distances increase, the effects of floor slope are amplified. Entry and exit doors occur at greater elevational differences, not necessarily in equal increments, which affects design of surrounding spaces and access patterns. Further, as aisle length increases with conventional seating, good practice requires cross aisles to ensure reasonable travel distance to exits. The cross aisle is a means of collecting exiting audience from more than one aisle, and is consequently quite wide. It eliminates two or more rows of seats. Increased seating area can also have a psychological effect on performers confronted

with fractional attendance that seems even smaller relative to empty seats. There are several alternatives to choose from in countering the results of larger size. Berry-patching, or horizontally offsetting sections of the audience area, answers the questions of aisle length and to some degree identifies smaller reference units for viewers, but introduces cross-aisles. A ledge may be incorporated, with or without a cross aisle, vertically offsetting the house floor and defining two places in the Room. Also, assigning seating priority to the lower section reduces apparent emptiness. Finally, a balcony solution brings about three places of different flavor. Each place provides a strong visual frame of reference more intimate than the total. The ability to shutdown or darken the balcony effectively removes it from the actors' estimate of the house. The problem of aisle slopes exceeding the maximum is removed; essentially, the steep area at the rear is lifted to form the balcony, acquiring an even steeper slope navigable by steps. Entry/exit is distinctly "two-story". Finally, lifting and tilting (the balcony) may enable it to be moved forward slightly, bringing more front row audience within range of the actor, and partially obscuring the rear of the house where the empty seats are. Sitting under a very deep balcony can sometimes be like sitting in another room. The rearmost row should at least be able to see the top of the proscenium. Balconies also tend to blanket an area acoustically, preventing reflected sound from reaching back rows. The acoustically acceptable overhang can be greater for Drama than for Music since the reverberant contribution is smaller. Moreover, since speech intelligibility favors a proportionally high direct/reverberant ratio, it improves with steeper floor rake and short throw. If amplified or pre-recorded sound is employed, correct positioning of loudspeakers may influence Room shape. Normally, a central loudspeaker cluster is located over the stage so that the actor and loudspeaker are equidistant from the listener. The acoustic shadow cast by a low balcony can be a problem best dealt with by raising the balcony.



Initial Time Delay Gap
<20 Milliseconds - Sounds Merge
≥70 Milliseconds - Sound Perceived as Echo

Figure 22
 Direct and reflected sound

A pure tone can only be generated artificially; most sounds are composed of many frequencies.

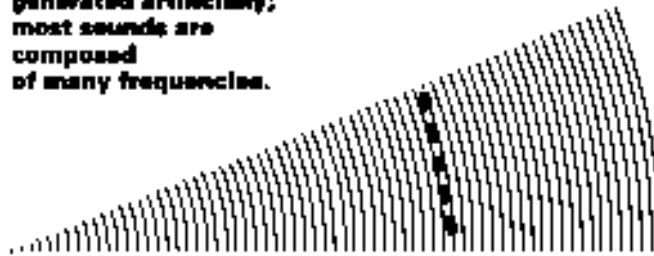

No reflection by invisible baffle (some diffraction will occur).

Small panels are invisible to low frequencies.
600 Cycles/Second = 2' Wavelength
100 Cycles/Second = 11' Wavelength

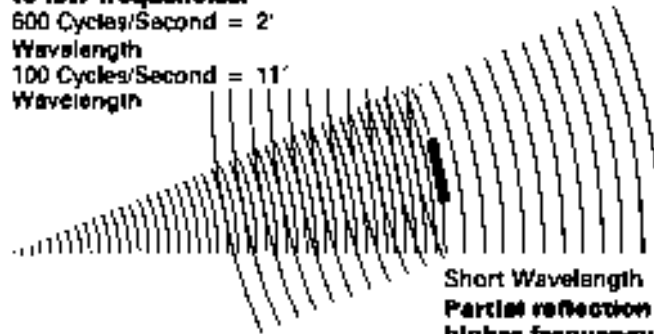

**Short Wavelength
Partial reflection of
higher frequency**

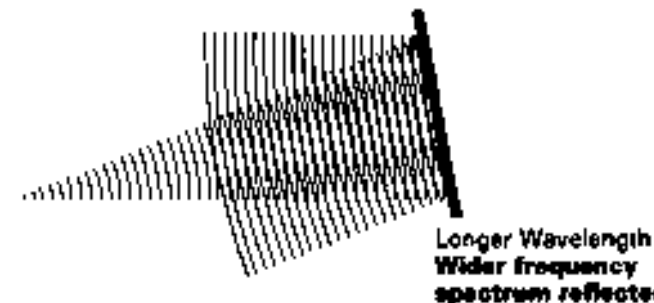

**Longer Wavelength
Wider frequency
spectrum reflected**

Figure 23

Frequency reflective reflection

5.2 MUSIC HOUSES

5.2.1 SEATING AREA DIMENSIONS. The acoustical importance of the audience area is its contribution to the Room's total sound absorption, which is a significant factor in reverberation time (R_t). For a given R_t , absorption is proportional to volume (three-dimensional size). The design of chairs for Music audiences is a critical concern because the most absorptive element in the Room is people. The acoustic character of the Room should not vary greatly due to attendance rates. Thus, the absorption spectrum of an empty chair should roughly approximate one occupied by a human body. Since people absorb sound, tighter average spacing of seats (7 to 8 s.f.) may be called for to reduce the total absorption area. This is more likely to be important for very large audiences when conservation of sound energy is critical. It is the total absorption of the Room that matters. Hence, absorption influences criteria for sound retentive construction as well as the volume required.

5.2.2 PLAN ARRANGEMENT WITH RESPECT TO STAGE. Plan geometry for Music has as much if not more to do with wall positions than with the audience distribution. The form of stage enclosure and its transition to the house influences Room shape. Musicians may be located in the Room on an open stage, or in an enclosure at one end. Small Frontal Rooms favor the orchestra-in-the-Room condition; whereas larger Rooms favor the orchestra-in-enclosure. Because direct sound dominates the small Room, the directional enclosure is less advantageous than a high ceiling (for reverberant volume). With increased absorption (people) and distance from source, the reverse is true; large Rooms have directional enclosures to boost direct sound levels. The smaller of plan dimensions (usually width) may determine the first reflection time (intimacy) and also the potential for troublesome standing waves. This dimension should be at least 30 feet for Music, 15 feet for speech. It is normally a concern for small Rooms. In larger Rooms, the proximity and orientation of surfaces near the stage control first reflections.

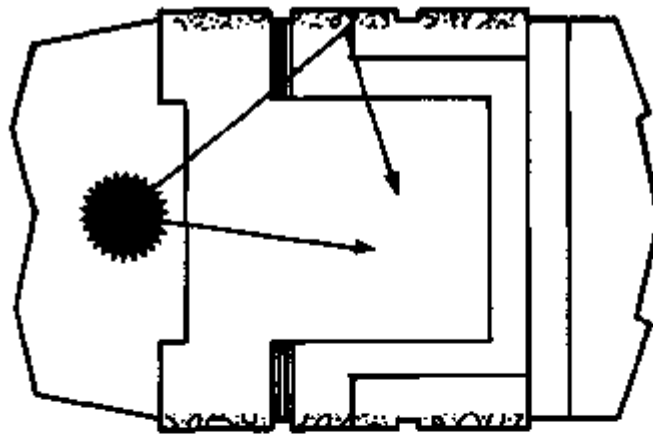

**Avoid Parallel
Reflective Surfaces
That Cause Flutter Echo
and Standing Waves**

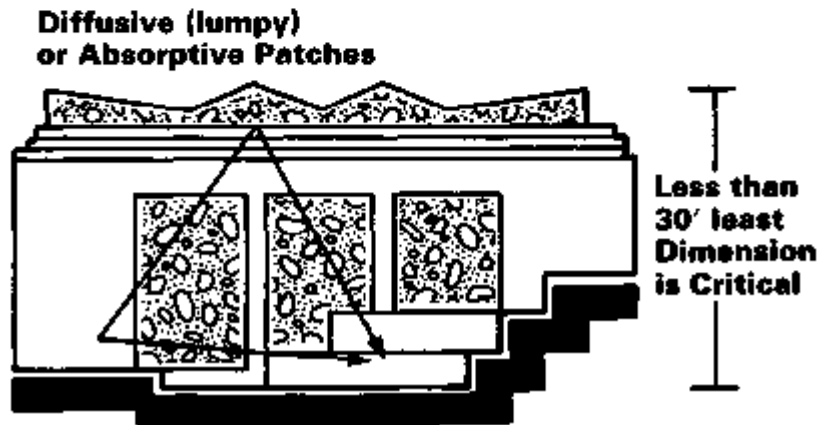

Figure 24

Small music room considerations

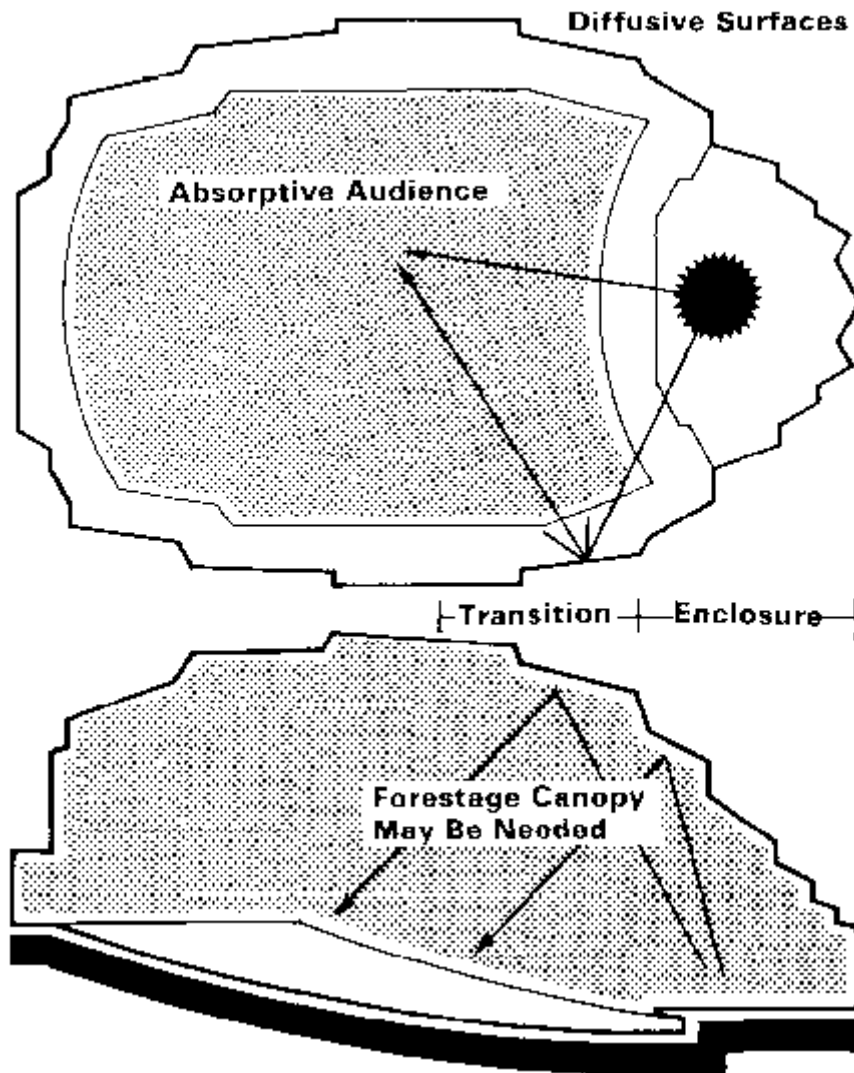

Figure 25

Large music room considerations

To avoid flutter echoes, no two walls should be parallel. Reflecting walls are shaped to distribute rebounding sound. Surface variations should include a large range of sizes “seen” by various wavelengths in the audible range (from $\frac{1}{2}$ ” = 20,000 cps to 50 feet = 20 cps) and especially at mid-frequencies (3 to 8 feet). Great variation yields sound a common problem in balconies of larger halls. Balconies can have unpleasant consequences for occupants of other portions of the Room. Depth should be limited to 1-1/2 times the vertical opening, and soffits widened to reflect sound to seats.

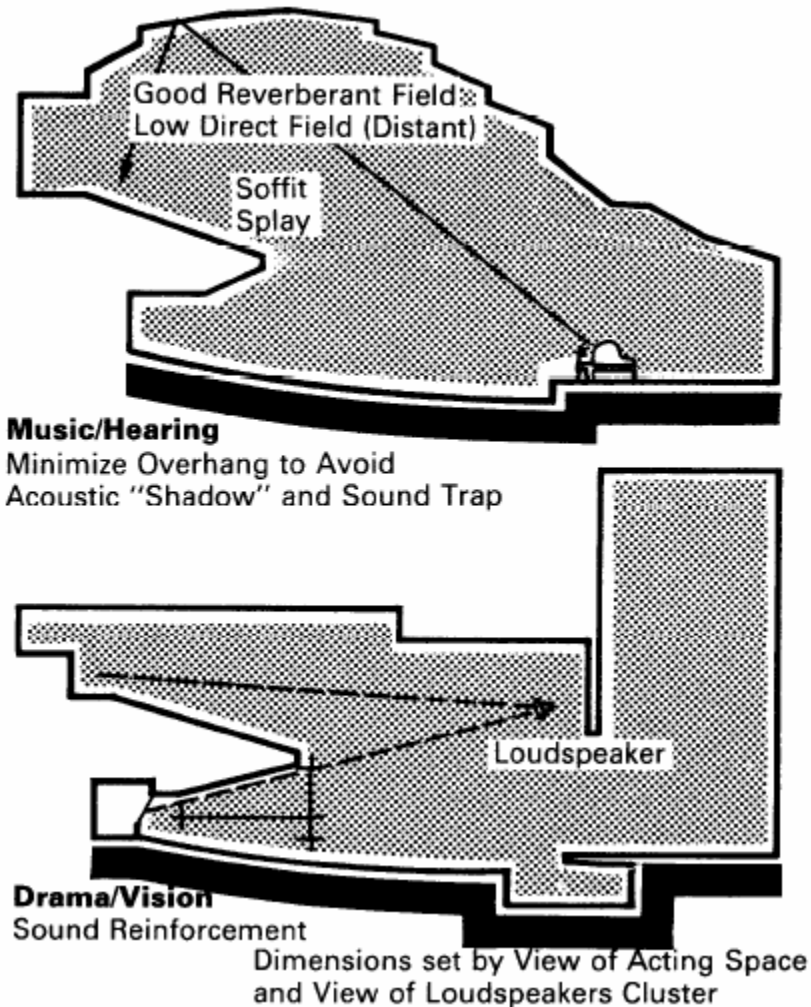

Figure 26

Balconies – music or drama

The upturned fronts can focus certain frequencies on the musicians platform and should be tilted and rumped for diffusion. Balcony or box seats near the front corners of the House typically have poor sightlines and receive late reflections. Nonetheless, this feature of traditional concert hall design is a useful way to provide diffusion and early reflections to the main seating area. With an orchestra in the pit, front box seats are often the finest of good diffusion and uniformity of blend. Room length is related to potential for echo from long delayed reflections off the rear wall. The wall may be tilted or rumped for diffusion. Focusing curvatures are sometimes a problem of large Rooms that conform to vision

criteria for seating. Fan-shaped Rooms must be examined for potential sound traps (acute intersections) and uneven distribution of reflections.

5.2.3 VERTICAL ARRANGEMENT WITH RESPECT TO STAGE. Sound is a spherical phenomenon; similar considerations apply to both horizontal and vertical shape. Floor slope affects the portion of direct sound received at distant seats. Tilting the audience exposes them to a larger wedge of radiating energy. Small Rooms can afford to have flatter floors since the general level of direct sound is high. Increasing the available volume (which increases reverberant contribution) will permit steeper floors. The factor of least (smallest) dimension applies vertically as well as in plan. Since the ceiling height of a small Room is likely to be less than or near 30 feet, it is wise to build in undulations ensuring its non-parallel relationship to the floor. As the Room size and height increase, the ceiling over center forestage plays a major role in providing early first reflections to center seats. If the ceiling must rise for volume, a partial suspended canopy may be required. Reverberant field in large Rooms does not fall off so rapidly as direct sound. The evenness of reflected sound distribution is therefore important. Much of this characteristic relates to the ceiling transition shape, progressively slanted to reflect sound into the audience where it's needed. Balcony seats have the advantage of nearness to the ceiling; initial-time-delay is very short and reverberant field rich. However, weak direct sound is a common problem in balconies of larger halls. Balconies can have unpleasant consequences for occupants of other portions of the Room. Depth should be limited to 1-1/2 times vertical opening, and soffits widened to reflect sound to seats. The upturned fronts can focus certain frequencies on the musicians platform and should be tilted and ruffled for diffusion. Balcony or box seats near the front corners of the House typically have poor sightlines and receive late reflections. Nonetheless, this feature of traditional concert hall design is a useful way to provide diffusion and early reflections to the main seating area. With an orchestra in the pit, front box seats are often the finest.

6. THE STAGE. Stage dimensions and volumetric relationships have a fundamental effect in establishing the geometries of the House. This section will build on discussion of the House to help determine what makes one Stage configuration different from another. Afterward variations of Stage and House will be brought together for evaluation. The physical characteristics of the Stage are functions of its intended use. Seven performance types pertinent to Frontal Stage criteria will be looked at briefly to see where they differ.

6.1 GENERAL CONSIDERATIONS. Variations among Stage forms have two levels of impact on Room design-Vision parameters (location of audience) and Hearing parameters (location of boundary surfaces).

6.1.1 VISION PARAMETERS. These are related to the dimensions of the acting area:

- Width/depth/shape of acting area
- Height of proscenium (if any)
- Elevation and/or rake of stage
- Location of acting area relative to proscenium

6.1.2 HEARING PARAMETERS. These are related to boundaries of the Stage enclosure:

- Size/shape of enclosing shell (if any)
- Nature of coupled volumes (if any)
- Absorptive properties of enclosure
- Location of sound source relative to enclosure

The corresponding functional elements depend on the use for which the Stage is designed. A few categorical terms will be of help in comparative treatments of stage types. Performing (acting) area is the portion of stage space meant to be seen. The stage enclosure defines a volume contiguous with the stage space, communicating with the house. Together, these constitute the bare minimum Open Stage. The stage floor may be stepped or sloped (“raked”). If a wall divides the stage space from the house the opening in it is the proscenium and the volume behind it is stagehouse. For Music, an enclosure within the stagehouse is a shell; its overhead extension into the house is a

forestage canopy. If a portion of the remaining stagehouse volume communicates with the house, it is said to be coupled. For Drama, scene space surrounds the acting space, and is surrounded by working space within the stagehouse-around, above or below. An open stage can have scene and working space, but scenic material may not be withdrawn vertically unless there is a proscenium wall and flyloft; i.e., a stagehouse-separable from the audience house by a fire curtain closure. Below-stage working space (trap room) must also be separated from the house except through the proscenium. An orchestra pit communicates with the house in front of the proscenium and fire curtain. The reader will find it necessary to refer to other sections of this discussion for a more detailed treatment of some topics, such as performance accessory equipment, environmental systems, and access considerations. However, there are a few “no option” requirements that relate to stagehouse construction especially. Safety is one; quantities of scene materials and fabrics suspended over hot lights, wood flooring, rigging lines, wiring and electrical equipment, power tools, and a lot of independent activity make the theater stage a potentially hazardous region. The best protection is alertness and goodhousekeeping. Additionally, materials used in the stagehouse or stored there shall be fire-retardant. If a flyloft is built, the proscenium wall must have a 2-hour fire-rating and self-closing incombustible fire curtain, roof vents (at least 5% of floor area) activated by smoke and heat detectors, automatic sprinklers, and 2½" diameter firehose standpipes at each side. Sprinklers are required below the stage, too. If there is no flyloft (stagehouse ceiling less than five feet above proscenium), no fire curtain is required. Stage floors are designed for 125 to 150 psf live load, grid-irons for 75 psf, with head and loft block beams designed for 250 plf. All permanent floor structures shall be non-combustible except the stage floor deck, which in almost all cases should be white pine or fir softwood tongue and groove, totalling 2" thick. It should have a matte finish and be built in sections enabling repair and replacement. This construction extends six feet past the proscenium offstage.

6.2 FUNCTIONAL REQUIREMENTS. The following are desirable Stage characteristics for various performance types. Also refer to respective sketches and to detail data regarding special equipment and construction criteria. The discussion here stresses key functions and design rationale.

6.2.1 LEGITIMATE DRAMA. The medium includes speech, action and scenic context. The human figure is extremely important; scenic illusion refers to this for dimensional scale. Dominant movement across the acting area, entering left and right, makes other entries special events. Drama usually works through sustained continuity over a series of unfolding, developing events and situations; the ability to control changes in context, pace, center of attention and atmospheric tone is essential.

Performance Space: Acting area is approximately 35' w x 20' d (40' x 25' usual maximum). This defines the downstage zone of most action; however, the full stage depth is utilized. It has a level floor that can be built upon, normally 30 to 36" above the front row of the house. Traps are recommended in key acting areas.

Enclosure: A stagehouse is recommended, with a proscenium portal 35' w x 26' (can be larger). Stagehouse configuration is related to scene handling methods; flyloft is recommended strongly.

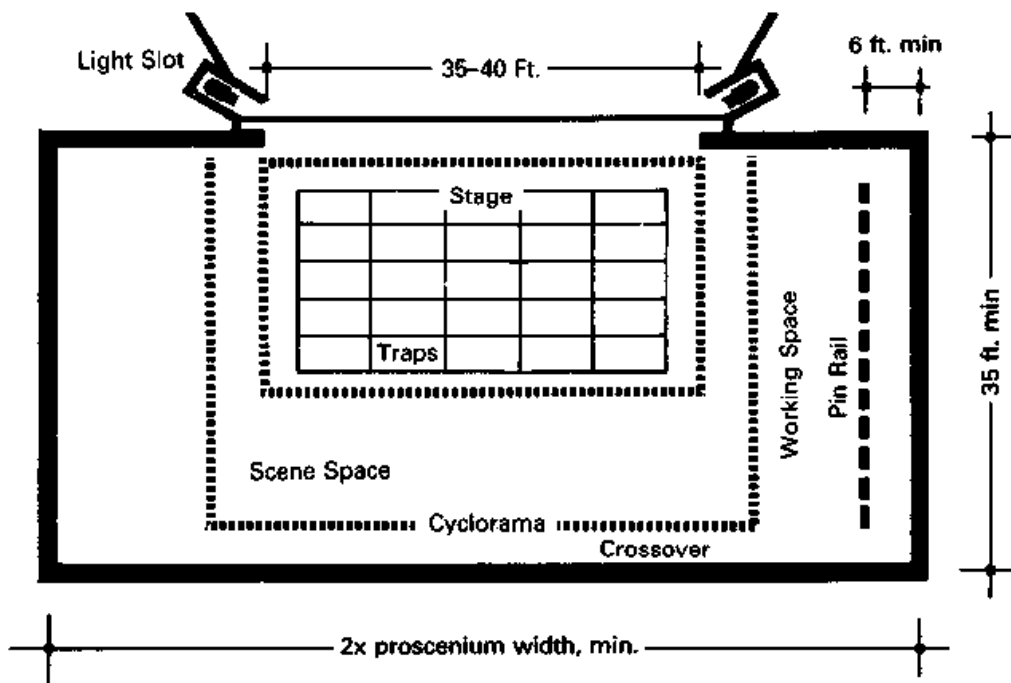

Figure 27
Drama stage

Scene/Working Space: Wrap-around scene space is required for flats, drops and wagons. Allow ample horizontal working space for the largest set piece plus actors' passage, waiting areas, technicians' workspace, counterweights and pinrail, as well as curtain space and switchgear. Use inside clearances and keep the plan shape compact and rectangular. Overhead working space must accept the longest flown piece plus borders plus grid-iron and line space plus manhigh passage above grid. Understage working space should be at least 8-foot clear height. If any portion of the working space is omitted by design, stage level allocation should be increased by 50%.

6.2.2 DANCE. The medium consists of action with music and some scenic context. Large movements of dancers in two directions (to-fro, side-side) physically occupy a region 15 feet above the floor. Dancers' entry from scene space on all sides is important. Scenery is often minimal, but not stage lighting. Although recorded music can be used, a dance facility should provide for a live orchestra. A dance concert usually consists of a series of separate pieces or events with rest periods in between, during which the stage is reset and the audience must be otherwise occupied. The technical qualities that help sustain continuity during performance should be versatile and sophisticated, especially lighting controls. Also, music is to be heard on stage distinctly.

Performance Space: Acting area is typically 50' w x 40' d, although 40' width will accommodate modern dance and small troupes. Higher sightlines (lower stage in steeper house) improve perception of deep movements. Construction of a resilient dance floor is essential, e.g. on built-up criss-crossed sleepers with neoprene cushions in between. Sponge mats are not springy enough, and injuries can result. Often, a removable linoleum, vinyl or hardboard surface is put down, with seams taped.

Enclosure: A high proscenium is needed in large Rooms for clear view of the dancers' space, or no proscenium at all in intimate Rooms. Stagehouse requirements relate to scenery components.

Scene/Working Space: Scene space at each side is usually devoted to entry legs and tabs for the depth of the stage. A cyclorama or backdrop is frequently used. Unimpeded crossover passage is very important, preferably wide enough for costumed dancers to pass each other without disturbing drapery, etc. Wing space must accommodate assembled dancers. An orchestra pit is very desirable for 20 to 50 musicians.

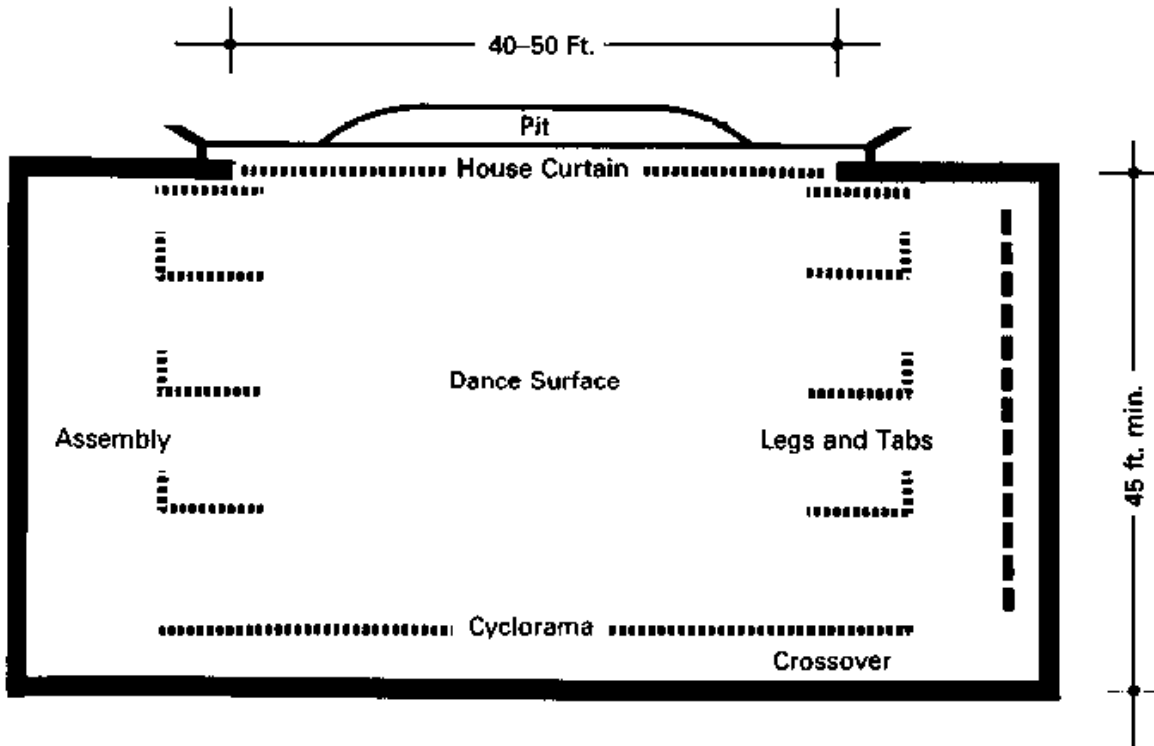

Figure 28
Dance stage

6.3 MUSIC-DRAMA. Speech, music, action and scenic components are all incorporated in this form of presentation, sometimes called light opera or musical comedy. It is similar to straight drama in its storyline continuity, which demands directorial skill in successfully alternating speech, song and dance, and also relies heavily on stagecraft and technical support. The musical component is a key feature of transitions, requiring expert control. A relatively large cast and crew is typical with up to 50 people on stage at once and

quantities of scenery to manage. Coordinating all this activity is a problem requiring, extensive preparations and an excellent communications system during performance.

Performance Space: Although principal attention is generally focused downstage, background "chorus" activity and the ability to have "cross talk" at the same time makes a wide, deep acting area desirable, about 60' x 45' deep. For a given production, this can be masked down. The floor should be danceable, although it needn't be very sophisticated in construction; the ability to build on and anchor to it is as important. Traps and pit-type cyclorama are desirable.

Enclosure: A 30' to 35' high proscenium arch is recommended, along with the flyloft stagehouse. Stagehouse proportions recognize that wingspace is as important as loft space.

Scene/Working Space: Wrap-around scene space must accept a large variety of rather elaborate scenery. The dimension of this zone must allow for structural support of stand-up sets with recesses and overhangs, often in combination with flown portions. Wagon sets are very useful as well, but require substantial working space in addition to that for cast assembly, other properties and technicians. Symmetrical working space is advised, to simplify maneuvering during scene changes. Since live music is essential, provide an orchestra pit for 15 to 30 musicians.

6.4 ORCHESTRAL MUSIC. First identify the kind of orchestra for which the facility is primarily intended. Both its size and instrumental composition have a part in determining its characteristic sound, intensity, the literature emphasized, and requirements of physical arrangement. This suggests a Room designed for its "most likely" users, nevertheless involves tolerances for variations. Music concerts consist of a series of uninterrupted performance periods of varying length. In the intervals, instrumental components may be changed, reorganized and retuned while the audience, immobilized during performance, refreshes itself. The sometimes subtle alterations must be carefully prearranged in a rehearsal situation as similar to concert conditions as possible.

Performance Space: Orchestra set-ups are usually as compact as practicable, in order to hear each other, see each other, and share sheet music. Stage area averages 16 to 20 square feet per musician, and proscenium widths range from 55 to 80 feet.

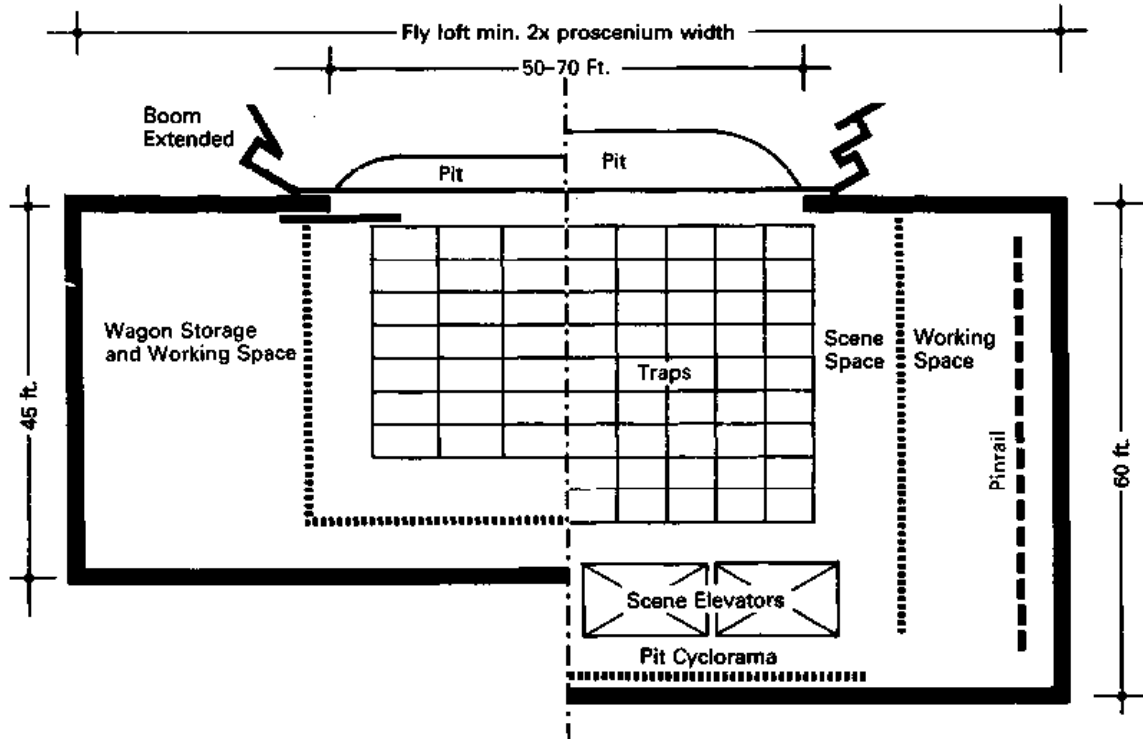

Figure 29

Music-drama: 50 foot proscenium stage

Grand opera: 70 foot proscenium stage

For various groups, this amounts to:

- Ensemble or band: 30-50 musicians, 800-900 S.f.
- Medium orchestra: 50-80 musicians, 1200-1500 s.f.
- Medium orchestra and chorus: 50-100 voices, 1800-2300 s.f.
- Symphony orchestra: 80-125 musicians, 2000-2400 s.f.
- Symphony and large chorus: 100-200 voices, 2800-3500 s.f.

Flexibility will help achieve sectional balance. A flat floor with portable riser platforms is advised, although some orchestras will not use risers. Performances with musicians and chorus often require extension forward and split-level arrangement with chorus behind orchestra. This can be accomplished on a large symphony stage with reduced orchestra, or by extension of an apron over the pit. Moving the orchestra forward alters the relationship to the enclosure.

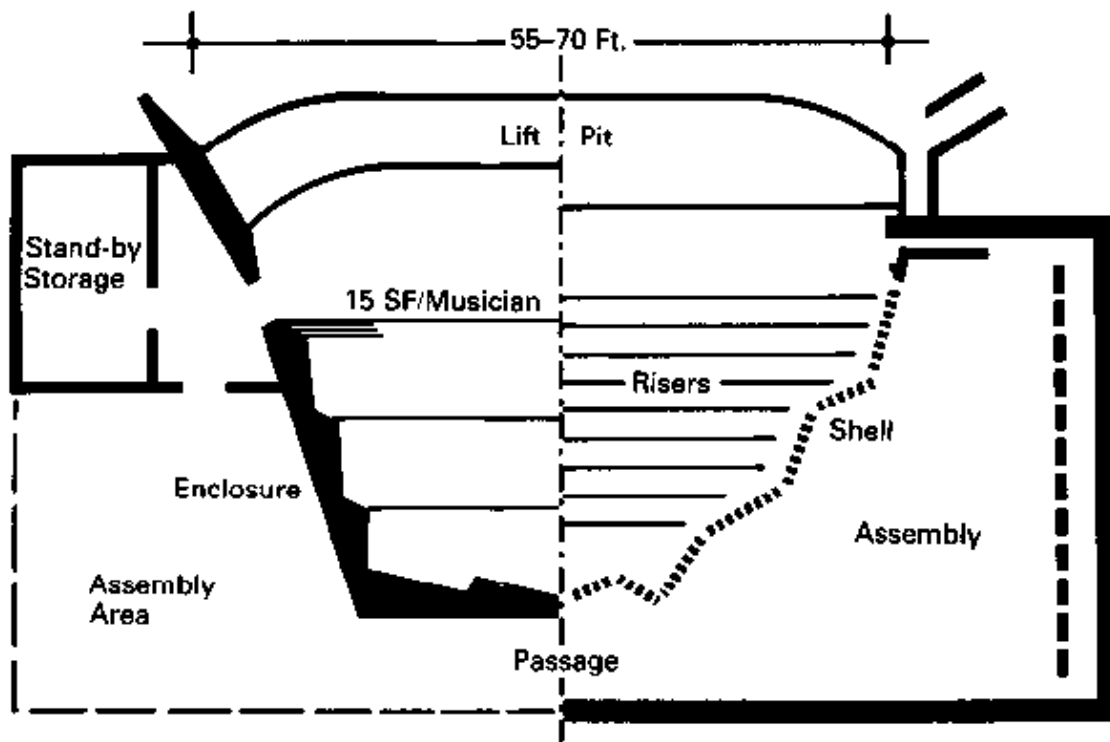

Figure 30
Orchestra-choral stage

Smaller music ensembles and bands can be accommodated on a theoretically large stage with suitable adjustment of enclosure and musician arrangement. Therefore, the suggested approach is to size the stage for the largest likely group. Stage floor construction noted is applicable, provided the deck is mounted with felt cushions under sleepers, variably spaced to dampen resonant vibration. If understage is unused, the structural base can be a ground slab.

Enclosure: Disregarding open stage forms applicable to small Rooms, two kinds of “sending end” enclosures are possible: the “hole in the wall” associated with traditional drama prosceniums, and the “horn” that gradually becomes the Room. The latter is permanent construction especially designed for Music use, with structural qualities similar to the House. The first type (proscenium) is normally employed in multi-use Rooms or theater conversions, consisting of a demountable shell erected in the stagehouse. Both types have a degree of geometric adjustability.

Scene/Working Space: Stagehouse functions, if any, are minimal for Music; most support activity takes place backstage or from control areas in the House. However, space adjoining the performance area should be allotted for performers’ assembly and temporary instrument standby (pianos, extra chairs and stands). There may also be separate rooms for broadcast, recording equipment and lighting switchgear. If there is a story below stage, thoughtful planning of freight lifts is needed to make the stage loading efficient. Installing a lift platform in the orchestra pit is recommended only if the acoustic enclosure design makes provision for the platform’s use as a performance area; i.e. if a proper forestage canopy is installed.

6.5 RECITAL. Instrumental and vocal recital rooms are the most intimate music spaces. The presentation format is similar to orchestral concerts, but musicians are fewer in number and share a much more personal relationship with the listener. Recital acoustics provide greater definition among instruments.

Performance Space: The platform area depends somewhat on anticipated music group sizes, 400 to 600 square feet typically. A low elevation, 24" to 30", is usual and portable risers may be employed for the larger groups or for choral performances.

Enclosure: The surfaces near the platform may be treated with adjustable panels that are reflective, absorptive or both. These are normally intended to adjust hearing on stage rather than project sound to the house, and a high degree of diffusion is desirable. The ceiling over the stage, or suspended reflectors, should be within 20 feet and no walls

parallel. Occasionally, a false or open work proscenium is used to support and screen lighting and audio equipment.

Scene/Working Space: No scenery is involved, unless the Room has secondary uses. Piano, risers and chairs are stored adjoining the stage. There should be a lounge to which musicians may retire, as well as dimmers for house and stage lights.

6.6 CHORAL. Basically a musical medium, group singing can have some of the characteristics of dramatic speech depending on the literature presented. Intelligibility is more important for secular works in terms of lyric continuity than for liturgical and choral-symphonic combinations. Choral requirements fall somewhere between those of a large recital hall and medium-sized orchestral facility, depending also on the number of voices.

Performance Space: A rather close packing of singers is desirable in most cases to facilitate their mutual hearing and visual contact. Instruments and music stands are not involved. Singers may be seated for long or intermittent performance, or may stand throughout. Between 5 and 9 square feet of stage area is needed per singer. Additional area should be allowed for piano or instrumental accompaniment. Portable adjustable risers in 8 inch increments are a definite advantage over fixed risers. The floor area is normally twice as wide as deep.

Enclosure: Recital or orchestral considerations are similar, although a shaped enclosure or shell is more likely to prove successful in larger Rooms. The human voice is relatively directional but not as powerful as many instruments until carefully trained, and rarely for sustained periods. The enclosures' function to blend, balance and contain sound energy is important.

Scene/Working Space: Similar considerations pertain to recital, although offstage assembly space must be larger and is best with entries provided from both sides of the performance area. For orchestral accompaniment a pit is desirable, and actually necessary for large scale events. The alternative is a very large open stage arrangement.

6.7 OPERA. Musical drama is the middle ground between operatic recital and grand opera, since it makes more or less equal use of song, speech, music, dance and scenic elements. Operatic recital emphasizes music and song over action and scenery, and grand opera may be considered song, music and spectacle. The storyline is often well known and diminishes in importance compared to musical execution. Traditionally, lavish costumery and settings are involved along with a large cast of singers and musicians supporting lead soloists. Opera recital may involve two or more small groups on a stage similar to that for musical drama or smaller, with minimal scenic devices and dance activity. Grand opera involves a great deal of background movement, multiple entry points, stagecraft, special effects, and scene changes.

Performance Space: Wider and deeper than others, it is typically 75' w x 55' d. Traps, multilevel constructions, stage elevators and lifts are used extensively. The great depth and width of stage is neither merely a tradition, nor the requirement of elephants, camels and chariots. Dramatic part-singing demands a great deal of movement on stage, reassembling of voices, and accommodation of a large chorus. Since it is difficult to sing while moving, the cast moves to new relationships with the soloists.

Enclosure: The opera proscenium is typically 65 to 80' wide and 40 to 50' high. This promotes acoustic coupling of the deep stage to the house and recognizes the probable height of a multi-tiered audience requiring good sightlines. The enormity of stage and stagehouse places premium value on trained, powerful voices and dramatic presence.

Scene/Working Space: Opera stages are often the most technically sophisticated, and the scenery is vast and expensive because of its importance to performance. A person on an empty opera stage is dwarfed. He must move from prop to carefully selected prop in order to maintain continuity of scale. Grand opera requires substantial scene space and offstage working space on all sides. A large, fully equipped flyloft, or a combination with scene elevators from below stage, is also needed. The flyloft must furnish generous flexible lighting points behind the proscenium and above stage, often including sidelighting towers in the wings. An orchestra pit is essential to grand opera. The pit

locates musicians properly relative to the action, but out of direct line of sight. It enables eye contact between the conductor and musicians and singers. It also enables singers and musicians to hear themselves best. Grand opera requires an especially large pit (80 musicians) and careful acoustic design. This design often reflects the nature of opera music; the pit has a mainly reverberant contribution at low intensity so as not to overpower voice intelligibility. The deep Bayreuth pit was developed expressly for Wagnerian opera, giving an eerie non-directional sound.

7. PRIMARY AND SECONDARY USES

7.1 FUNCTIONAL RELATIONSHIP OF STAGE TO ROOM. No single stage form can best satisfy the functional requirements of all performance types. But a given stage form can often accommodate more than one performance type:

7.1.1 WHERE THE SECONDARY PERFORMANCE TYPE makes the best of the circumstances and accepts/adapts to limitations of the primary form.

7.1.2 WHERE SOME OR ALL of the necessary additional facility is built into the primary form.

7.1.3 WHERE TEMPORARY DEMOUNTABLE MODIFICATIONS are provided to facilitate secondary use.

7.1.4 WHERE THE BEST PRIMARY CONFIGURATION is compromised to adapt to secondary uses.

In terms of primary use, the four alternatives above are listed in a descending order of desirability. While single-purpose Rooms are typically best suited for their uses, the likelihood is that some degree of multi-use will exist. Unfortunately, the prevalent tendency to begin with multi-use as a major design objective, too often leads to disappointing, costly failures. Attempts to “install” flexibility, take the form of mechanical devices; apron lifts and moving walls are the usual culprits.

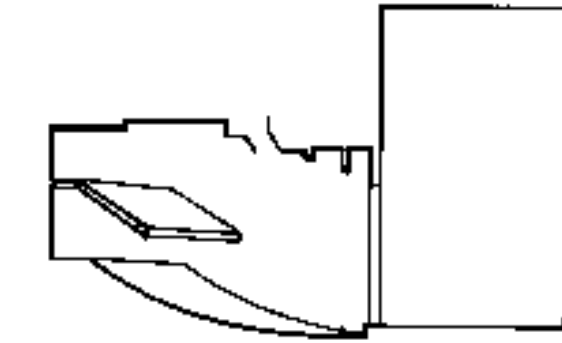

Library

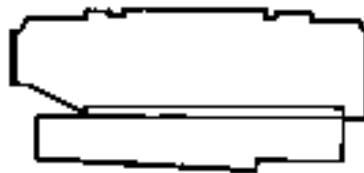

recital Hall

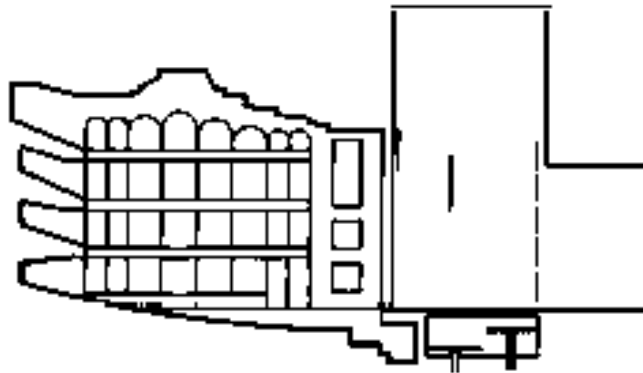

Opera or Dance



Orchestra Hall

Figure 31
Four kinds of single purpose rooms

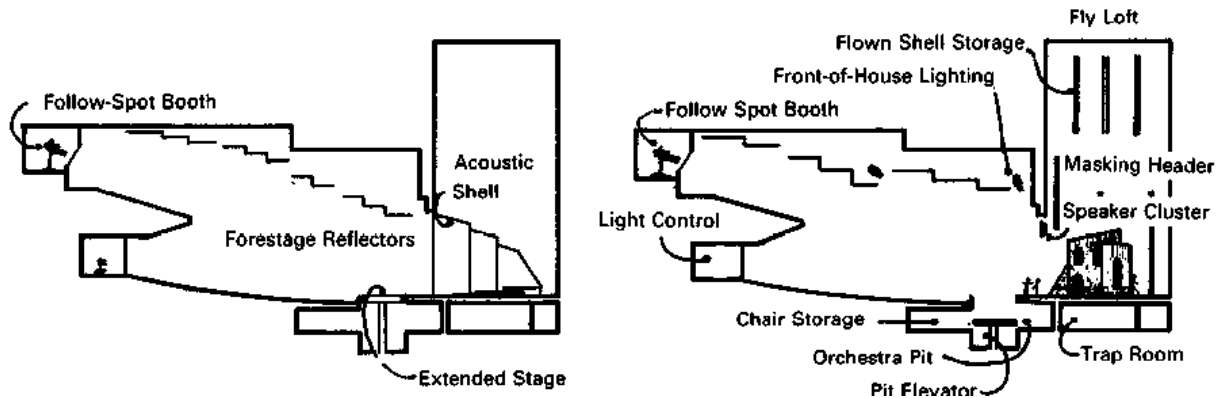

Figure 32
The multi-use room

Performance types can be grouped according to similarity of stage requirements as a first step, but it is important to bear in mind that both Stage and House are interdependent parts of the total Room. Any alteration of selection criteria for one has impact on the other particularly with regard to vision and hearing parameters. The audience arrangement in the House is based on the task of seeing action on the Stage, and this basis changes with the stage form and type of performance. The enclosure construction for both House and Stage corresponds to hearing tasks, and if the tasks or any part of the enclosure varies, adjustment may be required to obtain the best conditions.

7.2 SECONDARY USE CONSIDERATIONS. Having examined seven performance types of varying Drama and Music composition related to Stage requirements, the task remains to put Stage and House together again. A useful approach begins with the four Rooms, exploring the major characteristics of each by noting adjustments required to accept any of the secondary uses.

7.2.1 300 SEAT DRAMA ROOM. Consider a 300 seat House with Legitimate Drama Stage of minimum acceptable proportions: 35' wide proscenium with flyloft, 35' deep to backwall, approximately 3,000 net s.f. in the stagehouse. The fairly compact, intimate audience area will occupy 2,400 net s.f., but an allowance of 10% for structure and

inaccessible areas, plus at least 15% for control booths, service spaces and connecting circulation locks, yields a total Room of at least 7,200 gross square feet. The reverberant decay period for drama should be between 0.9 and 1.2 seconds. Based on an average of typical absorption spectrum for drama houses, Room volume will be about 75,000 cubic feet, for an average ceiling of 25' (all such figures are intended to be plausible, not model calculations). For the six other performance types, secondary use considerations are as follows:

7.2.1.1 Dance:

- Proscenium should preferably be wider than 35'. Therefore, stage depth should be deeper to permit crossover, and sightlines should be adjusted to take in deep stage.
- Flyloft should extend full depth if used.
- Require leg and tab drapes for entry on both sides.
- Require smooth resilient dance floor.
- Require music source, live or recorded, and appropriate Room acoustics, possibly.
- Require multiple, high quality followspots.
- High-rake house seating is preferable, with short view.
- Reverberant decay depends on music source; 1.0 to 1.2 seconds for electronic system is preferable.

7.2.1.2 MUSICAL DRAMA:

- Stage configuration similar to Dance.
- Extra stage depth is essential for scenery.
- Wingspace is essential for scenery and cast entry.
- Pit for musicians is essential. Pit space will consume a part of the prime audience seats.

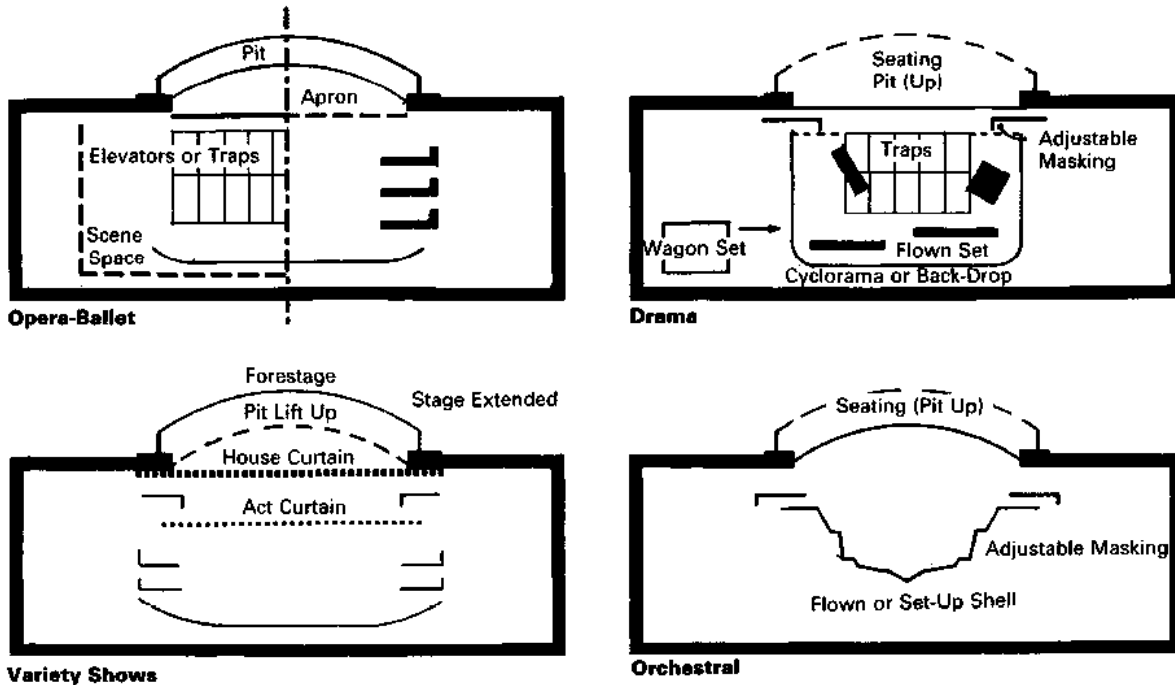

Figure 33
The multi-use stage

- Ensure proper reverberant decay 1.2 to 1.4 seconds = about 86-100,000 cu ft = avg 36 foot ceiling. Room must have sufficient volume for music (over-large for 300 seat drama) or electro-acoustic enhancement.
- Typically large “market” implies larger house, higher production cost, fewer performance units.
- Conclude larger Room desirable if substantial amount of Musical Drama is anticipated.

7.2.1.3 ORCHESTRAL:

- Music shell may be necessary in stagehouse.
- Greater volume needed rules out large groups.
- Small groups (dance band and chamber ensemble) require acoustic consideration of Room shape and volume, or electronic adjustment.
- Dance band with sound system requires 1.0 to 1.2 seconds, may be compatible.

- Classical chamber music requires 1.4 to 1.7 seconds, needs help.

7.2.1.4 CHORAL:

- Small choral group concerns are similar to Orchestral, but Room volume not as great a problem. 1.2 to 1.6 seconds preferable, perhaps attained with adjustable absorption, coupled volume, or electronics.
- Stagehouse reflectors or shell are desirable.

7.2.1.5 RECITAL:

- Longer reverberation is desirable, 1.4 to 1.7 seconds (similar to chamber orchestra).
- Intimate scale is desirable, low stage and close proximity to audience.
- Enclosure from stagehouse is desirable, probably necessary.
- Room proportions should preferably be narrower than likely Drama House, otherwise, use forestage canopy reflectors.

7.2.1.6 OPERA:

- It is not reasonable except as voice recital of simplest character.

7.2.2 650 SEAT DRAMA ROOM. Consider the same Legitimate Drama Stage as for the 300 seat Room. For a 35' wide proscenium, the first row and its aisles would not exceed 45' in width, and 300 seats would be within 50' viewing distance, an intimate Room. But 650 seats arranged in a rectangle would have the last row 115' from the Stage, well in excess of the optimum of 65'. In order to bring this row to 65', an average House width of 80' is needed; the last row would be 115' long with side aisles more than 30 degrees to the centerline. Such an extreme wedge might be acceptable for Thrust or Open Stage configuration, but not for Proscenium. Locating 500 seats on the main floor within 65' of the stage results in a wedge 75' at the rearmost row with side aisles just 13 degrees to centerline. The remaining 150 seats would occupy a six-row rear balcony; this is a good number since six rows do not exceed 20' as a dead end aisle. An additional 5' rear aisle, control booths, etc., will create about 800 GSF in the balcony and 5,333 GSF on the main

floor. Adding the stagehouse results in a total Room area of 11,333 GSF. For the appropriate reverberation period (0.9 to 1.2 seconds) between 130,000 and 160,000 cubic feet of volume is needed. Discounting by 50% the acoustically shadowed balcony area, an average ceiling of 30' is probable. The balcony would have an overhang ratio of about 2:1. The following are the secondary use considerations:

7.2.2.1 DANCE:

- Stage configuration concerns are similar to 300 seat.
- Sightlines become more critical for larger house, may require wider proscenium or projected stage. However, balcony mitigates the problem.
- Balcony design should consider acoustics and vision, as well as accommodate multiple follow-spots.
- Acoustical adjustment is more feasible than for Small Drama, suggesting desirability of live music and orchestra pit. Pit location should consider impact on seating capacity. 1.4 to 1.7 second delay is preferable for modest orchestra, or 1.2 to 1.4 with sound system.

7.2.2.2 MUSICAL DRAMA:

- Stage design should reflect need for more scene handling space (3,600 net s.f.) and direct loading from trailer trucks, in addition to the minimum requirements suggested for 300 seat house.
- It is preferable to build in pit space if Musical Drama is a substantial use.
- This is a reasonable capacity for Musical Drama, small for professional road shows, but modest for community theater.

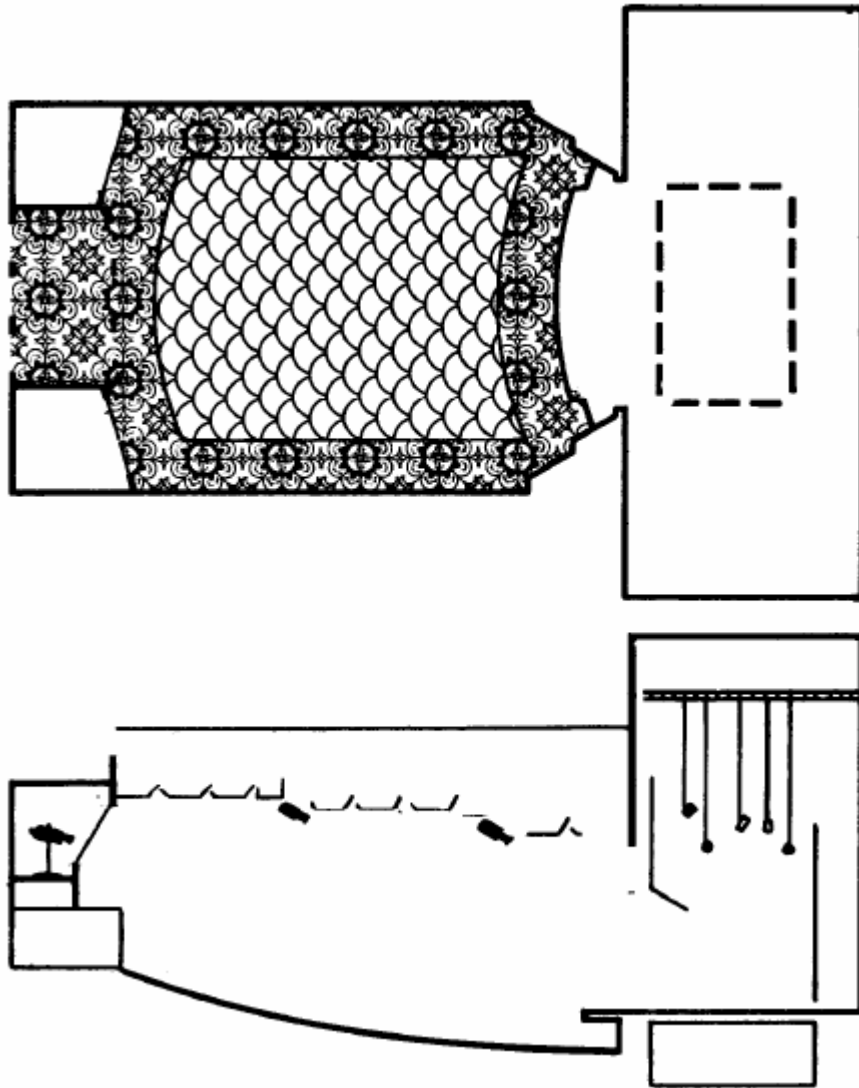

Figure 34
Drama Room – 300 seat

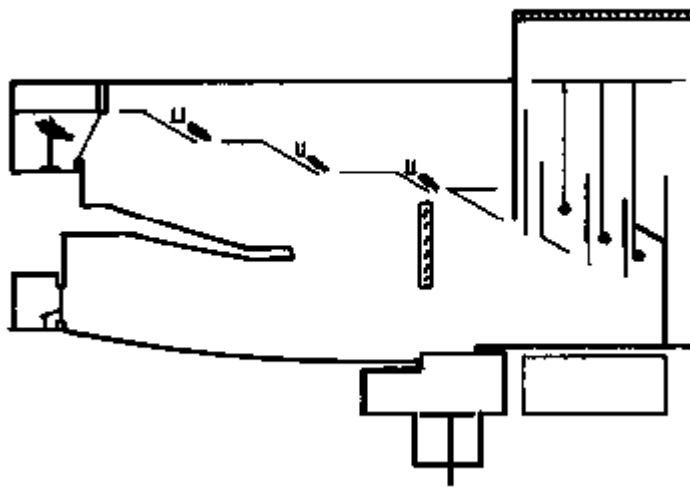
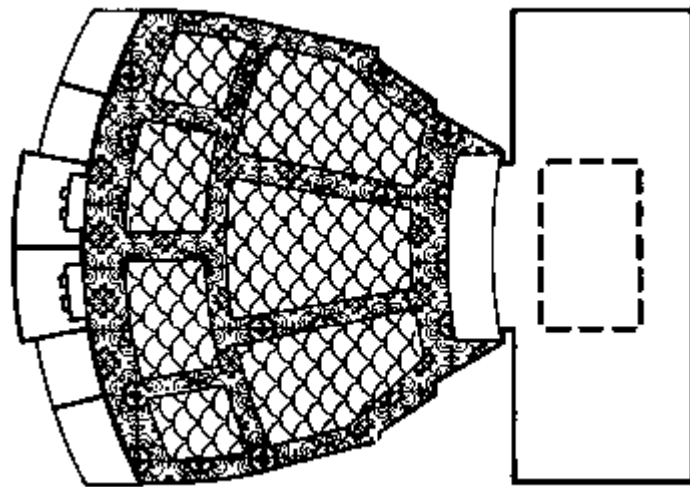

Figure 35
Drama Room – 650 seat

7.2.2.3 ORCHESTRAL:

- House size begins to be viable. With a substantial flown orchestra shell, a 40-piece group could be comfortable within the 35' proscenium. Retractable legs permitting enlargement of the opening by 10' would accommodate 70 musicians.
- As the orchestra increases in size, longer reverberation is generally desirable for blending of sound. At 1.5-1.9 seconds, for contemporary works or Mozart symphonies, Room volume would preferably be 50% greater (250,000 cu. ft.). However, this creates a relatively “live” house unsuitable for primary Drama use. If medium-size orchestra is contemplated as a fairly regular event, electro-acoustic enhancement is advised.
- Conclude that primary Drama use is not readily compatible with larger orchestral works.

7.2.2.4 CHORAL:

- A demountable shell designed to reduce sound losses in the stagehouse would make choral presentation possible.
- Substantial choral works are typically written for orchestral accompaniment, and are therefore likely to be limited according to pit accommodations for musicians. A string/woodwind ensemble and 40 voices could reasonably occupy the stage without pit.
- Decay time slightly longer (1.2 to 1.6 seconds) than for Musical Drama would be appropriate for choral compositions in which lyrics must be intelligible.
- Choral music that needs blending (Handel) should have 1.7 to 2.0 seconds decay. An electronic system is recommended.
- Liturgical music, composed for reverberation extending 2 to 3 seconds or more, could not be finely accomplished even with electronics. The audience will immediately note the artificial character of “big sound” in a small Room.

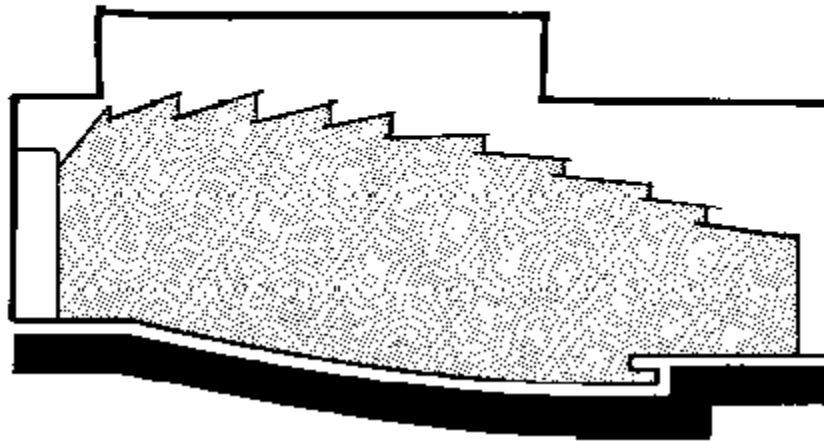
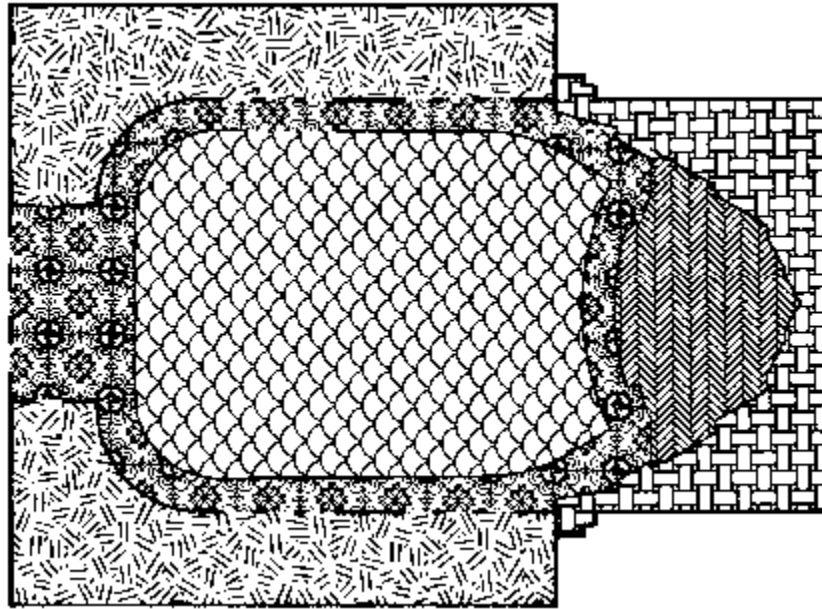

Figure 36
Music Room – 650 seat

7.2.2.5 RECITAL:

- Refer to the comments noted under 300 seat similar.
- Absorptive quality of the drama house and scale of stage tend to make the recital problematic without electronic assistance and careful visual setting.

- The first problem, absorption, is especially critical with a balcony arrangement that is a bit too deep. Over-sizing the volume for Music and introducing added absorption for Drama (the primary use) will compromise voice audibility and require speech amplification.
- The secondary problem, stage scale for solo or small group music, can be overcome by design and provision of a shell.
- If Drama use is primary, recital should have electronic assistance.

7.2.2.6 OPERA:

- Light opera amounts to Musical Drama, although somewhat longer reverberation improves music quality. A reduced version of classical opera, verging on operatic recital, could be managed on a Musical Drama stage enlarged slightly. The lack of reverberance would be noticeable as would the small orchestra accommodated in the pit.
- Professional opera singers would definitely require rehearsal to modulate the intensity of their voices in a small Room.

7.2.3 650 SEAT MUSIC ROOM. Consider a room shaped for 650 seat music presentation. It may have an Open Stage with suspended canopy, or an enclosure transitional with House surfaces, with the ceiling turning down behind the platform equipped with reflective elements of various sizes. The 14,000 s.f. platform (55 x 25) would accommodate 70 musicians. Seats and aisles will occupy 4,600 net s. f. on one level, with the farthest seat about 80' from the stage. Reverberation time of 1.8 seconds or more would be provided by 225,000 cubic feet of volume in a Room averaging 40' in height, but not necessarily rectangular in three dimensions. Continental seating would require many doors (about 10) to corridors on each side; total gross area of 9,000 s.f. yields a net/gross ratio of 67%. Small and moderate sized instrumental groups are most appropriate. Long reverberation would suit most symphonic works and could be shortened. A rehearsal curtain is probably required. Secondary uses are possible as follows:

7.2.3.1 LEGITIMATE DRAMA:

- In the Open Stage version, a large motorized wall might divide the house volume in half, 50 seats placed on part of the stage, and absorption added to help offset 41,000 cubic feet of excess volume. This would yield a 375 seat Drama House needing electronic reinforcement.
- The resulting square plan would have minimal scenery; actors' entries would have to be considered in platform design, and traps built in.
- It is improbable for legitimate theater.

7.2.3.2 DANCE:

- It is conceivable that a limited dance presentation is possible without stagehouse and scenic material.
- Musicians (small ensemble) could be seated on stage or house floor.
- Extension into the house is limited by fixed seat orientation.
- Stage proportions would preferably deepen, perhaps with an apron extension. A dish seating plan would make this more feasible.
- Alternatively, simple drapery or freestanding masks might serve the entry/proscenium function.

7.2.3.3 MUSICAL DRAMA:

- Importance of scenery, orchestra pit, stagehouse and cast size, as well as fire safety, etc., prohibit this use in any practical sense.

7.2.3.4 CHORAL:

- Risers required on stage.
- Piano accompaniment may be sufficient for very large chorus (200); instrumental accompaniment requires balance adjustment of enclosure for a combined 150 voices and 15 instruments all on stage. Larger orchestra and chorus combinations involve stepped stage extension and additional adjustable reflectors or electronics.
- 1.8 second reverberation is just right for most choral works, but could be adjusted.

- It is substantially a good Room for choral performance.

7.2.3.5 RECITAL:

- This is close to “one room” intimacy; appropriate visual scale is attained with careful lighting.
- Room proportions are important to avoid “big sound” or hollowness; a bit large. Careful location of the music source may also compensate first reflection weaknesses, or adjustment of enclosure and canopy.
- Reverberation is a bit long for recital (should be 1.4 to 1.7 seconds) and will tend to increase due to the empty stage.
- Instrumental or vocal recital is possible.

7.2.3.6 OPERA:

- Opera recital is appropriate, especially with the addition of simple wingspace and false proscenium (3,000 s.f.). A relatively high stage or split level construction to counter the low angle of audience vision obviates the need for a pit.
- Reverberation is a bit long, should be 1.3 to 1.6 seconds.
- Grand opera is not reasonable without the scenic element.

7.2.4 1400 SEAT MUSIC ROOM. An orchestra platform in an end-of-Room enclosure approximately 70' wide and 35' deep (2,450 net s.f.) will seat 115 to 125 piece symphony orchestra. Seats occupy 9,800 net s.f.; a rectangle 70' x 740' (with conventional seating, 2 sections of 14 seats per row, 50 rows deep) would be too long for vision and direct sound levels. Make one shallow, three-legged balcony seating 300, leaving a main floor 110' long. The balcony is five rows deep at rear and two rows deep at sides, which extend 70' toward the stage. Gross area of the Room (including Stage) is about 14,500 s.f., but balcony access will require corridors and stairs, for a total of 16,500 GSF (75% net/gross). Reverberation time of 1.6 to 2.0 seconds requires 450 to 480,000 cubic feet, with an average ceiling height of 45'.

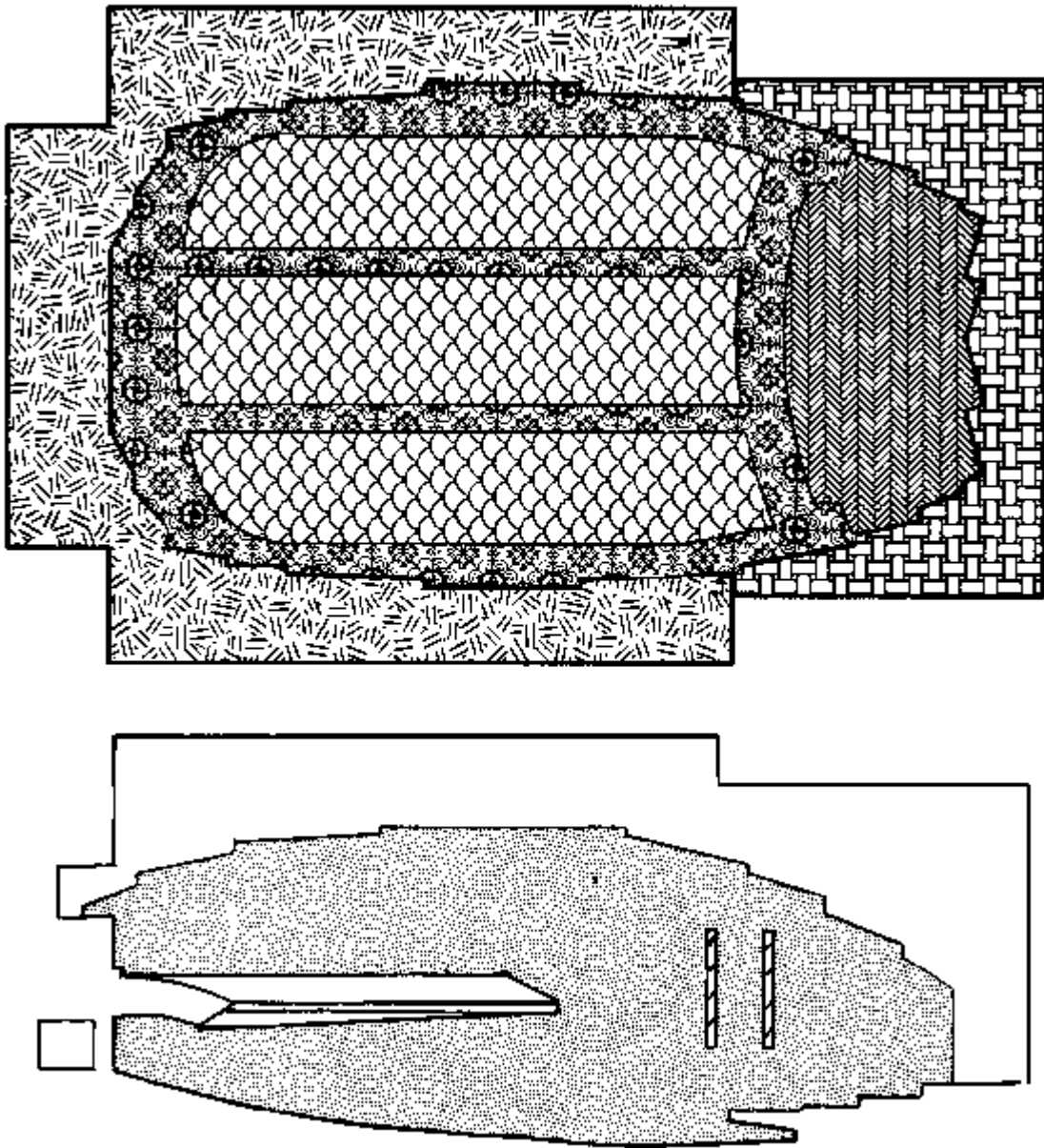

Figure 37
Music Room – 1400 seats

The Room described is a traditional concert hall. It will be suitable for full symphonic music. Its reverberant volume is medium for symphony, since a smaller House than typical for American halls means a proportionally higher component of direct sound relative to reverberation. However, definition and clarity of tone are considered desirable for contemporary music. The following secondary uses are limited:

7.2.4.1 LEGITIMATE DRAMA:

- It is not possible.

7.2.4.2 DANCE:

- It has similar concerns of 650 seat Music, without the benefit of Open Stage suspended grid.
- Existence of balcony improves potential for Dance, although the house size would mean extreme distance from rear seats.
- Extension into audience would be more feasible, especially with 3-side balcony, but extension introduces problems of entry of dancers, stage lighting, and reorienting fixed seats. Not likely except for “rug concert” seatless occasions.

7.2.4.3 MUSICAL DRAMA:

- Provision of stagehouse and pit (4,500 s.f.) is essential.
- Stagehouse accommodations may dispense with flyloft if generous offstage and wingspace are included. This means compromise of the primary use by the the requirement of demountable orchestra shell.
- Orchestra pit is essential for reasonably unobstructed vision and Drama lighting angles.
- Reverberation time should be cut drastically. Introduction of sufficient absorption will select out mid and high frequencies, resulting in a weak, unnatural voice quality. Selective sound reinforcement would be desirable.
- House size and viewing distance sightlines are acceptable for infrequent Musical Drama use, or Broadway revues.

7.2.4.4 CHORAL:

- 50 musicians and 200 voices could occupy the stage described without pit.
- With an extended stage for more musicians, large works (Beethoven’s Ninth Symphony) are possible.
- With 50 musicians in an 800 s.f. pit, major choral works for 350 voices might be heard.

- Reverberation time would be just right (1.7 to 2.0 seconds desirable).

7.2.4.5 RECITAL: Chamber music and small ensembles would not suffer greatly if some adjustments were made, especially at the stage enclosure.

- Skillful lighting and backdrop design can mitigate apparent distortion of human scale.
- The Room is slightly large for recital intimacy, and is too reverberant (1.4 to 1.6 seconds desirable).

7.2.4.6 OPERA:

- Provision of stagehouse and pit are essential (5,000 s.f.).
- Operatic drama begs for a flyloft, deep stage and generous orchestra pit. Operatic drama also fares better with shorter sightlines and more intimacy than afforded by the plan described. This typically leads to the high, tiered horseshoe plan.
- Serious consideration of opera would begin at this capacity normally; in particular “intimate” opera as opposed to Wagnerian spectacle.
- Treated as light opera, Musical Drama considerations would apply with somewhat less success dramatically, but better performance musically.
- If serious effort is to be devoted to opera, consider designing the Room for it, since opera criteria combine requirements for orchestral Music and large scale Drama.